

Setting up

Base unit

- Use only the included Panasonic AC adaptor PQLV203.

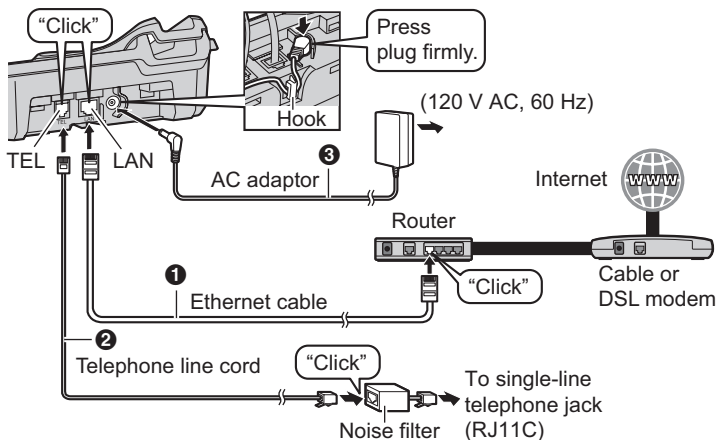

Handset

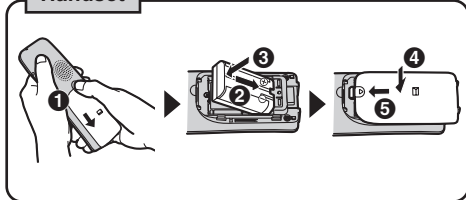

CHARGE 7 HOURS

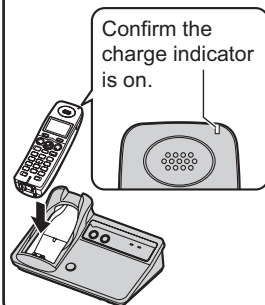

- Model shown is BB-GT1500.

For product assistance, visit www.panasonic.com/help
For joip assistance, visit www.joip.com

Setting up

joip

① To use the joip IP line, read the Terms of Use for the joip services on the included leaflet or at www.joip.com

② Press **[YES]**.

③ Wait until the STATUS indicator turns green.

④ Confirm your joip number.

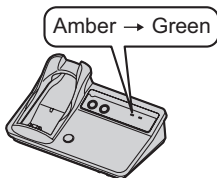
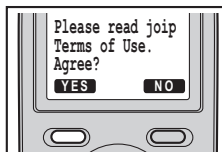

● Model shown is BB-GT1500.

⑤ Wait for a joip text message for the joip website password (www.joip.com). To view the message, see below.

Note:

- If "Please read joip Terms of Use. Agree?" is not displayed in step ②, press **[IP]**.
- When the STATUS indicator on the base unit does not light in green even if you wait for a few minutes, see "STATUS indicator" (page 6).

Viewing the joip text messages

- 1 **[MENU]** → **[#][3][6][0]**
- 2 **[▼]/[▲]**: Select the desired item. → **[OK]**
- 3 **[OFF]**

For product assistance, visit www.panasonic.com/help

For joip assistance, visit www.joip.com

Operating tips

[]: shows button names.

Using the joystick

The handset joystick can be used to navigate through menus and to select items shown on the display, by pushing it up [▲], down [▼], left [◀], or right [▶].



Adjusting audio volume

Push the joystick up [▲] or down [▼] repeatedly while talking.

Handset soft keys

The handset features 2 soft keys and a joystick. By pressing a soft key, or by pressing the center of the joystick, you can select the feature shown directly above it on the display.

[SELECT], [SAVE], [OK], and additional other functions are assigned to soft keys. Pay attention to soft keys to find functions you need during handset operation.

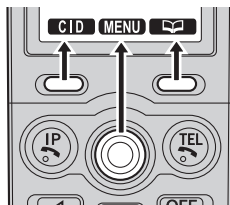

Middle soft key

The joystick can be used to select the center soft key icon, by pressing down on the center of the joystick.



Date and time (Handset)

- 1 [MENU] → [Ⓜ][1][0][1]
- 2 Enter the current month, date, and year by selecting 2 digits for each.
- 3 Enter the current hour and minute (12-hour clock format) by selecting 2 digits for each.
- 4 [AM/PM]: Select "AM" or "PM". → [SAVE] → [OFF]

For product assistance, visit www.panasonic.com/help

For joip assistance, visit www.joip.com

Basic operation (Handset)

Making calls	<p>1 Dial the phone number.</p> <p>2 To make a landline call, press [TEL]. To make a joip internet call, press [IP].</p> <p>Note:</p> <ul style="list-style-type: none"> • To call a Panasonic GLOBARANGE phone, dial the joip number consisting of a # followed by 10 digits.
Answering calls	<p>To answer the landline call, press [TALK], [TEL] or [☎].</p> <p>To answer the joip internet call, press [TALK], [IP] or [☎].</p>
Adjusting the receiver/speaker volume	Push the joystick up [▲] or down [▼] while talking.
Viewing the caller list and calling back	[CID] → [▼]/[▲] : Select the desired item. → [TEL]/[IP]
Ringer volume	<p>1 [MENU] → [⇄][1][6][0][1] (IP line)/ [⇄][1][6][0][2] (landline)</p> <p>2 [▲]/[▼]: Select the desired volume. → [SAVE]</p>

BB-GT1540 Basic operation (Base unit)

Making calls	<p>1 To make a landline call, press [TEL]. To make a joip internet call, press [IP].</p> <p>2 Dial the phone number, and then speak into the MIC.</p> <p>Note:</p> <ul style="list-style-type: none"> • To call a Panasonic GLOBARANGE phone, dial the joip number consisting of a # followed by 10 digits.
Answering calls	<p>To answer the landline call, press [TEL] or [☎].</p> <p>To answer the joip internet call, press [IP] or [☎].</p>
Adjusting the speaker volume	Press [▲] or [▼] repeatedly while talking.
Ringer volume	<p>1 Press [IP/TEL] repeatedly until the display shows the desired line ([IP] or [TEL]).</p> <p>2 Press [▲] or [▼] repeatedly to select the desired volume.</p> <ul style="list-style-type: none"> • To turn the ringer off, press and hold [▼] until the unit beeps.

For product assistance, visit www.panasonic.com/help
For joip assistance, visit www.joip.com

BB-GT1540 Answering system (Base unit)

Auto answer on	<ol style="list-style-type: none"> 1 Press [IP/TEL] repeatedly until the display shows the desired line(s) ([IP] and/or [TEL]). 2 Press [ANSWER ON].
Auto answer off	Press [ANSWER ON] .
Recording your greeting message (max. 2 minutes)	<ol style="list-style-type: none"> 1 Press [IP/TEL] repeatedly until the display shows the desired line(s) ([IP] and/or [TEL]). 2 [GREETING REC] 3 Within 10 seconds, press [GREETING REC] again. 4 Speak clearly about 20 cm (8 inches) away from the MIC. 5 To stop recording, press [STOP].
Listening to new messages	When [▶] flashes on the center of navigator key, press [▶] .
Erasing a message	Press [ERASE] during playback.
Using the answering system remotely	<ol style="list-style-type: none"> 1 Dial your phone number from a touch tone phone. 2 After the greeting message starts, enter your remote code. (Default remote code is "111".) <ul style="list-style-type: none"> • The unit plays back new messages. • After playing back new messages, the voice guidance starts. 3 Follow the voice guidance as necessary.

Quick troubleshooting

STATUS indicator

Status		Cause/solution
Color	Light pattern	
Green	On	• Ready to make/receive jOip internet calls.
	Flashing	• Downloading data, please wait.
Red	On	• On for about 3 seconds during initial startup. (Normal)
	Flashing	• The base unit is registering a handset. Please wait.
	Flashing rapidly	• The base unit is paging handsets. (BB-GT1500)

Quick troubleshooting

STATUS indicator



Status		Cause/solution
Color	Light pattern	
Amber	On	<ul style="list-style-type: none"> The base unit's IP address may conflict with the IP addresses of other devices on your local network if you have set the static IP address. We recommend using the automatic setup (default): <ol style="list-style-type: none"> [MENU] → [#][5][0][0] [▼][▲]: "on" → [SAVE] → [OFF]
	Flashing	<ul style="list-style-type: none"> The base unit is registering with the joip service. Please wait. If the STATUS indicator continues flashing: <ul style="list-style-type: none"> If you have set the static address, we recommend using the automatic setup (default): <ol style="list-style-type: none"> [MENU] → [#][5][0][0] [▼][▲]: "on" → [SAVE] → [OFF] Many installation issues can be resolved by resetting all the equipment. First, shut down your modem, router, base unit, and computer. Then turn the devices back on one at a time in this order: modem, router, base unit, computer. If you cannot access Internet Web pages using your computer, check to see if your Internet service provider is having connection issues in your area. For more troubleshooting help, visit www.joip.com or contact the joip service provider.
OFF	—	<ul style="list-style-type: none"> joip internet calls are not available. Check the following: <ul style="list-style-type: none"> The base unit's AC adaptor is connected. Set up for joip use (page 2). The Ethernet cable is connected. Your network devices (hub, router, etc.) are turned on. Check the LEDs for the link status of the devices.

For further information, refer to the STATUS indicator section in the Operating Instructions.

For product assistance, visit www.panasonic.com/help

For joip assistance, visit www.joip.com

Frequently asked questions

Question	Cause/solution
<p>The unit does not work.</p>	<ul style="list-style-type: none"> ● Make sure the battery is installed correctly and fully charged. ● Unplug the base unit's AC adaptor to reset the unit. Reconnect the adaptor and try again. ● The handset has not been registered to the base unit. Register the handset as explained later in this guide.
<p>I cannot hear a dial tone for the IP line.</p>	<ul style="list-style-type: none"> ● Confirm the Ethernet cable is properly connected. ● You have not agreed to the Terms of Use for the joip services. To use the joip IP line, you need to agree to it using the handset. ● If you cannot make or receive internet calls or if you are experiencing any other issues with your VoIP telephone service provided by deltathree, Inc., visit www.joip.com
<p>I cannot hear a dial tone for the landline.</p>	<ul style="list-style-type: none"> ● Confirm the telephone line cord is properly connected. ● Disconnect the unit from the telephone line and connect a known working telephone. If the working telephone operates properly, contact Panasonic service personnel to have the unit repaired. If the working telephone does not operate properly, contact your landline service provider.
<p>How can I increase handset volume level?</p>	<ul style="list-style-type: none"> ● Push the joystick up repeatedly while talking.
<p>The VM indicator on the base unit flashes. Example: BB-GT1540</p> 	<ul style="list-style-type: none"> ● You have new voice mail messages received by your landline service provider and/or joip. For further information, refer to the Voice Mail section in the Operating Instructions.
<p>BB-GT1540: The message indicator on the base unit flashes.</p> 	<ul style="list-style-type: none"> ● You have new messages received from the landline and/or joip IP line by the unit's answering system. For further information, refer to the answering system section in the Operating Instructions.

For other questions, please refer to the Operating Instructions or visit the web sites below.

For product assistance, visit www.panasonic.com/help
For joip assistance, visit www.joip.com

Quick troubleshooting

Handset shows:

“No link to base. Move closer to base, try again.”

Place the handset on the base unit, then check if the charge indicator is on.

- Model shown is BB-GT1500.

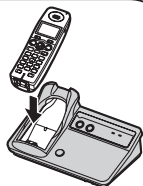

The charge indicator is OFF.

Unplug and then plug AC adaptor properly to both the base unit and AC outlet.

The charge indicator is ON.

Lift the handset, then try again. If handset still shows the same message, try re-registration as explained later in this guide.

Re-registration failed.

Unplug the AC adaptor of the base unit and remove the battery from the handset, then plug in the AC adaptor and insert the battery into the handset again. Try re-registration as explained later in this guide.

Re-registration failed.

Your telephone may need service.
Please visit <http://www.panasonic.com/help> for further troubleshooting.

Registering a handset to base unit

The included handset and base unit are preregistered. If for some reason the handset is not registered to the base unit, register the handset.

Handset

Press **[MENU]**, then press **[#][1][3][0]**.

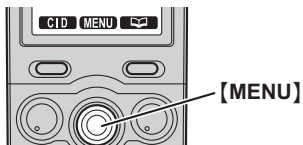

Base unit

BB-GT1500

Press and hold **[HANDSET LOCATOR]** until the STATUS indicator flashes in red.

- Complete next step within 90 seconds.

BB-GT1540

Press and hold **[LOCATOR/INTERCOM]** until the registration tone sounds and the STATUS indicator flashes in red.

- Complete next step within 90 seconds.

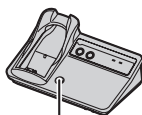

[HANDSET LOCATOR]



[LOCATOR/INTERCOM]

Handset

Press **[OK]**.

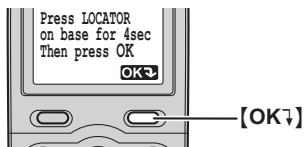

For product assistance, visit www.panasonic.com/help
For joip assistance, visit www.joip.com

IMPORTANT!

If your product is not working properly. . .

joip customer support

joip is the VoIP service provided by deltathree, Inc. for this phone. If you cannot make or receive internet calls or if you are experiencing any other issues with your VoIP telephone services, please contact joip customer support:

- Visit **www.joip.com** or send an email to **support@joip.com**
- Call ***JOIP (*5647)** from your GLOBARANGE phone using the IP line.
- Call **1-877-NOW-JOIP (1-877-669-5647)** using the landline.

For your phone's functions or features, please contact Panasonic.

- 1 Read this **Quick Guide** or **Operating Instructions**
 - If you lost the Operating Instructions, you can download a copy at <http://www.panasonic.com/help>
- 2 Visit our website:
<http://www.panasonic.com/help>
 - FAQs and troubleshooting hints are available.
- 3 Contact us via the web at:
<http://www.panasonic.com/contactus>
- 4 Call us at:
1-800-211-PANA (1-800-211-7262)
 - Monday - Friday 9:00am - 9:00pm (EST),
Saturday/Sunday 10:00am - 7:00pm (EST)

To order a replacement battery,
please call: 1-800-332-5368

Or visit: <http://www.panasonic.com/batterystore>