

Panasonic[®]

Installation Guide

Home Network System Smart Plug

Model No. **KX-HNA101FX**



Thank you for purchasing a Panasonic product.

This document explains how to install the smart plug properly.
For details about how to use the system, refer to the User's Guide
(page 11).

Please read this document before using the unit and save it for future reference.

Table of Contents

Important Information

Graphical symbols for use on equipment and their descriptions	3
About this system	4
For your safety	4
Important safety instructions	5
For best performance	5
Other information	6













Setup

Part names and functions	8
LED indicator	8
Setup overview	8
Connections	9
Registering the smart plug	10
Wireless communication range	10

Appendix

Testing the smart plug	11
Features available when using the [Home Network] app	11
Accessing the User's Guide	11
Specifications	12
Trademarks	12

Graphical symbols for use on equipment and their descriptions

Symbol	Explanation	Symbol	Explanation
	Alternating current (A.C.)		Class II equipment (equipment in which protection against electric shock relies on Double Insulation or Reinforced Insulation)
	Direct current (D.C.)		"ON" (power)
	Protective earth		"OFF" (power)
	Protective bonding earth		Stand-by (power)
	Functional earth		"ON"/"OFF" (power; push-push)
	For indoor use only		Caution, risk of electric shock

About this system

- This system is an auxiliary system; it is not designed to provide complete protection from property loss. Panasonic will not be held responsible in the event that property loss occurs while this system is in operation.
- The system's wireless features are subject to interference, therefore functionality in all situations cannot be guaranteed. Panasonic will not be held responsible for injury or damage to property that occurs in the event of wireless communication error or failure.

For your safety

To prevent severe injury and loss of life/property, read this section carefully before using the product to ensure proper and safe operation of your product.

WARNING

Power connection

- Use only the power source marked on the product.
- Do not overload power outlets. This can result in the risk of fire or electric shock.
- Completely insert the product into the power outlet. Failure to do so may cause electric shock and/or excessive heat resulting in a fire.
- Regularly remove any dust, etc. from the product by pulling it from the power outlet, then wiping with a dry cloth. Accumulated dust may

cause an insulation defect from moisture, etc. resulting in a fire.

- Unplug the product from power outlets if it emits smoke, an abnormal smell, or makes an unusual noise. These conditions can cause fire or electric shock. Confirm that smoke has stopped emitting and contact an authorised service centre.
- Unplug from power outlets and never touch the inside of the product if its casing has been broken open. Danger of electric shock exists.
- Never touch the plug with wet hands. Danger of electric shock exists.
- Do not connect non-specified devices.
- Before connecting an electric device to this product, make sure the electric device meets the specifications described on page 12. Using unspecified devices may cause fire or smoke.

Installation

- Install this product in accordance with the provided instructions.
- To prevent the risk of fire or electrical shock, do not expose the product to rain or any type of moisture.
- Do not place or use this product near automatically controlled devices such as automatic doors and fire alarms. Radio waves emitted from this product may cause such devices to malfunction resulting in an accident.
- Panasonic will not be held responsible for damage or injury caused by improper connection, installation, or usage.

Operating safeguards

- Unplug the product from power outlets before cleaning. Do not use liquid or aerosol cleaners.
- Do not disassemble the product.
- Never put metal objects inside the product. If metal objects enter the product, turn off the circuit breaker and contact an authorised service centre.
- Use this product to supply power only to devices which can be operated safely remotely. Do not connect the following.
 - Cooking appliances, irons, or other devices that generate a large amount of heat. There is a risk of fire, burns, and injury.
 - Power tools, electric machinery, or other devices that could cause injury and therefore must be used under direct, careful observation.
 - Heating or cooling devices, or any type of device which could cause health risks, particular to the elderly or to small children, and therefore should be used only when usage conditions can be confirmed.
 - Medical devices. This product is not intended to be used when providing medical care.

Medical

- Consult the manufacturer of any personal medical devices, such as pacemakers or hearing aids, to determine if they are adequately shielded from external RF (radio frequency) energy. DECT features operate between 1.88 GHz and 1.90 GHz with a peak transmission power of 250 mW.

- Do not use the product in health care facilities if any regulations posted in the area instruct you not to do so. Hospitals or health care facilities may be using equipment that could be sensitive to external RF energy.

CAUTION

Installation and location

- Never install the product during a lightning storm.
- The socket-outlet shall be installed near the equipment and shall be easily accessible.

Important safety instructions

When using your product, basic safety precautions should always be followed to reduce the risk of fire, electric shock, and injury to persons, including the following:

1. Do not use this product near water for example, near a bathtub, washbowl, kitchen sink, or laundry tub, in a wet basement or near a swimming pool.

SAVE THESE INSTRUCTIONS

For best performance

Hub location/avoiding noise

The hub and other compatible Panasonic devices use radio waves to communicate with each other.

Important Information

- For maximum coverage and noise-free communications, place your hub:
 - at a convenient, high, and central location with no obstructions between the product and hub in an indoor environment.
 - away from electronic appliances such as TVs, radios, personal computers, wireless devices, or other phones.
 - facing away from radio frequency transmitters, such as external antennas of mobile phone cell stations. (Avoid putting the hub on a bay window or near a window.)
- If the reception for a hub location is not satisfactory, move the hub to another location for better reception.

Environment

- Keep the product away from electrical noise generating devices, such as fluorescent lamps and motors.
- The product should be kept free from excessive smoke, dust, high temperature, and vibration.
- The product should not be exposed to direct sunlight.
- Do not place heavy objects on top of the product.
- When you leave the product unused for a long period of time, unplug the product from the power outlet.
- The product should be kept away from heat sources such as radiators, cookers, etc. It should not be placed in rooms where the temperature is less than 0 °C or greater than 40 °C. Damp basements should also be avoided.
- Operating the product near electrical appliances may cause interference.

Move away from the electrical appliances.

Other information

Routine care

- Wipe the outer surface of the product with a soft dry cloth.
- Do not use benzine, thinner, or any abrasive powder.

Disposal of Old Equipment (Only for European Union and countries with recycling systems)



This symbol on the products, packaging, and/or accompanying documents means that used electrical and electronic products must not be mixed with general household waste. For proper treatment, recovery and recycling of old products, please take them to applicable collection points in accordance with your national legislation.

By disposing of them correctly, you will help to save valuable resources and prevent any potential negative effects on human health and the environment. For more information about collection and recycling, please contact your local municipality.

Penalties may be applicable for incorrect disposal of this waste, in accordance with national legislation.

For business users in the European Union

If you wish to discard electrical and electronic equipment, please contact your dealer or supplier for further information.

Information on Disposal in other Countries outside the European Union

This symbol is only valid in the European Union. If you wish to discard these items, please contact your local authorities or dealer and ask for the correct method of disposal.

Part names and functions

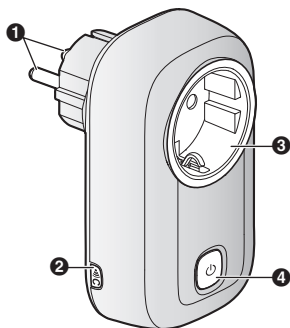

- 1 Power plug**
- 2 [(••)C]**
Used when registering the smart plug to the hub.
- 3 Power outlet**
- 4 [(⏻)] (on/off) LED indicator**
Turns the connected device on and off. Also serves as the LED indicator.

LED indicator

You can use the LED indicator to confirm the smart plug's status.

Indicator	Status
Off	No power, smart plug is off, or LED indicator is turned off ^{*1}
Green, lit	Smart plug is on ^{*1}

Indicator	Status
Green, blinking slowly	Registration mode
Red, blinking	Smart plug is out of range of the hub
Red, blinking very quickly	Connected electric device is drawing too much current or wattage ^{*2}

- ^{*1} You can configure the smart plug so that its LED indicator does not light during normal operation. For more information, refer to the User's Guide (page 11).
- ^{*2} In this case, the smart plug will turn off automatically. To turn the smart plug on again, disconnect it from the power outlet, disconnect the connected electric device, and then connect the smart plug to the power outlet.

Setup overview

- 1 Initial setup**
Make sure you can access the system using your mobile device. For details, refer to the System Setup Guide included with your hub.
- 2 Connection**
Connect the smart plug to the power outlet and connect the desired electric device to the smart plug.
- 3 Registration**
Required only if the smart plug was purchased separately (i.e., not as part of a bundle).

4 Confirm the usage area

Read the information in this document to confirm that the desired usage area is suitable to proper operation.

Connections

- ① Firmly insert the smart plug (A) into the power outlet.
- ② Firmly insert the AC plug of the desired electric device (B) into the smart plug.

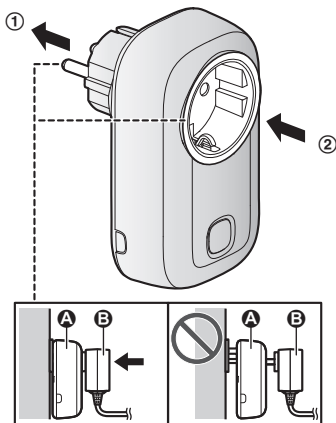

Note:

- You can turn the power supplied to the smart plug's power outlet on and off by pressing [⏻].
- When connecting a device with a large AC plug, use a short extension cord so that the AC plug of the connected device does not block the LED indicator/[⏻].

Note about connections

- The smart plug should be connected to a vertically oriented or floor-mounted AC outlet. Do not connect the smart plug to a ceiling-mounted AC outlet, as the weight of the smart plug may cause it to become disconnected.
- If the electric device connected to the smart plug draws more than 10 A or 2,400 W of power, the smart plug will turn off automatically.
- In the event of a power failure, the smart plug may not turn back on after power is restored. For this reason, connecting refrigerators or other devices that require constant power supply should not be connected to the smart plug.
- After connecting an electric device to the smart plug, make sure the smart plug is firmly connected to the power outlet.

Registering the smart plug

This procedure is not required for devices that were included as part of a bundle.

Before you can use the smart plug, it must be registered to the hub. If you purchased devices separately (i.e., not as part of a bundle), you must register each device to the hub.

You can register each device by using the registration buttons or the **[Home Network]** app.

Using registration buttons

- 1 Hub:**
Press and hold **[•)]C OTHER DEVICE]** until the LED indicator blinks slowly in green.
- 2 Smart plug:**
Press and hold **[•)]C]** until the LED indicator blinks slowly in green (page 8).
 - When registration is complete, the hub sounds one long beep.

Note:

- To cancel without registering the smart plug, press **[•)]C]** on the hub and on the smart plug again.
- If registration fails, the hub sounds several short beeps.

Using the app

When you register the smart plug by using the **[Home Network]** app, you can assign a name to your devices and group them by location. For more information, refer to the User's Guide (page 11).

Wireless communication range

The wireless communication range of each device in the system from the hub is approximately 50 m indoors and approximately 300 m outdoors. Wireless communication may be unreliable when the following obstacles are located between the hub and other devices.

- Metal doors or screens
- Walls containing aluminium-sheet insulation
- Walls made of concrete or corrugated iron
- Double-pane glass windows
- Multiple walls
- When using each device on separate floors or in different buildings

Note:

- The LED indicator blinks in red if it is out of range of the hub. In this case, confirm all connections, including those of the hub.

Testing the smart plug

After you have installed the **[Home Network]** app on your mobile device, you can use your mobile device to turn the smart plug on and off. For more information, refer to the User's Guide (page 11).

- 1 From the **[Home Network]** app home screen, tap **[Controlled Devices]**.
 - If a list of devices that can be controlled is displayed, tap **[Smart Plug]**.
- 2 Select the **[Individual]** tab.
- 3 Tap the desired smart plug's icon.
 - Confirm that the selected smart plug turns on and off when you tap its icon.

Features available when using the **[Home Network]** app

Some of the features that are available when using the **[Home Network]** app are listed below. For more information, refer to the User's Guide.



- **Remote power on/off**
You can turn the electric device on and off remotely, even when away from home.
- **Sensor integration**
You can configure the system to turn the electric device on when a sensor is triggered. (Sensor required.)
- **Timer on/off**

You can configure a timer to turn the electric device on and off at the desired times.

- **Excessive power notification**
The smart plug can monitor the power supplied to the connected electric device. If overcurrent or overwattage is detected, the smart plug sends a notification to the **[Home Network]** app.

Accessing the User's Guide

The User's Guide is a collection of online documentation that helps you get the most out of the **[Home Network]** app.

- 1 **iPhone/iPad**
Tap  in the app's home screen.
Android™ devices
Tap  or press your mobile device's menu button in the app's home screen.
- 2 Tap **[User's Guide]**.

Note:

- Microsoft® Windows® Internet Explorer® 8 and earlier versions are not supported.
- Android 4.1 or later versions are recommended.
- You can also access the User's Guide at the web page listed below.



www.panasonic.net/pcc/support/tel/homenetwork/manual/

Specifications

- **Standards**
DECT (Digital Enhanced Cordless Telecommunications)
- **Frequency range**
1.88 GHz – 1.90 GHz
- **RF transmission power**
Approx. 10 mW (average power per channel)
250 mW (max.)
- **Power source**
220 – 240 V AC, 50/60 Hz
- **Power consumption**
Standby: 0.8 W
Maximum: 1.6 W
- **Operating conditions**
0 °C – 40 °C
20 % – 80 % relative air humidity (dry)
- **Maximum wattage**
Approx. 2,400 W (10 A max. × 220 – 240 V)
- **Maximum current**
Approx. 10 A
- **IP rating*1**
IP20
- **Dimensions (height × width × depth)**
Approx. 113 mm × 64 mm × 35 mm, excluding the pins
- **Mass (weight)**
Approx. 174 g

*1 The IP rating indicates the product's ingress protection. This product is not designed to be waterproof.

Note:

- Design and specifications are subject to change without notice.
- The illustrations in these instructions may vary slightly from the actual product.

Trademarks

- iPhone and iPad are trademarks of Apple Inc., registered in the U.S. and other countries.
- Android is a trademark of Google Inc.
- Microsoft, Windows, and Internet Explorer are either registered trademarks or trademarks of Microsoft Corporation in the United States and/or other countries.
- All other trademarks identified herein are the property of their respective owners.

For your future reference

We recommend keeping a record of the following information to assist with any repair under warranty.

Serial No.	Date of purchase
(found on the rear of the unit)	
Name and address of dealer	

Attach your purchase receipt here.

Panasonic Corporation

1006, Oaza Kadoma, Kadoma-shi, Osaka 571-8501, Japan

<http://www.panasonic.com>

© Panasonic Corporation 2016