

Panasonic®

Operating Instructions

Home Network System Keychain Remote

Model No. **KX-HNK102FX**



Thank you for purchasing a Panasonic product.

This document explains how to operate the keychain remote properly. For details about how to use the system, refer to the User's Guide (page 12).

Please read this document before using the unit and save it for future reference.

Table of Contents

Important Information

Accessory information	3
About this system	4
For your safety	4
Important safety instructions	5
For best performance	5
Other information	6

Setup

Part names and functions	8
LED indicator	8
Setup overview	9
Inserting the battery	10
Attaching the key ring	10
Registering the remote	11
Wireless communication range	11

Appendix

Using the remote	12
Features available when using the [Home Network] app	12
Accessing the User's Guide	12
Specifications	13

Accessory information

Supplied accessories

No.	Accessory item/Part number	Quantity
①	Battery*1	1
②	Key ring	1

*1 When replacing the battery, refer to the battery specifications noted under "Power source" on page 13.

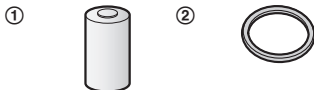

Other information

- Design and specifications are subject to change without notice.
- The illustrations in these instructions may vary slightly from the actual product.

Trademarks

- iPhone and iPad are trademarks of Apple Inc., registered in the U.S. and other countries.
- Android is a trademark of Google Inc.
- Microsoft, Windows, and Internet Explorer are either registered trademarks or trademarks of Microsoft Corporation in the United States and/or other countries.
- All other trademarks identified herein are the property of their respective owners.

About this system

- This system is an auxiliary system; it is not designed to provide complete protection from property loss. Panasonic will not be held responsible in the event that property loss occurs while this system is in operation.
- The system's wireless features are subject to interference, therefore functionality in all situations cannot be guaranteed. Panasonic will not be held responsible for injury or damage to property that occurs in the event of wireless communication error or failure.

For your safety

To prevent severe injury and loss of life/property, read this section carefully before using the product to ensure proper and safe operation of your product.

WARNING

Power connection

- Use only the power source marked on the product.
- Do not connect non-specified devices.

Installation

- To prevent the risk of fire or electrical shock, do not expose the product to rain or any type of moisture.
- Do not place or use this product near automatically controlled

devices such as automatic doors and fire alarms. Radio waves emitted from this product may cause such devices to malfunction resulting in an accident.

Operating safeguards

- Do not disassemble the product.

Medical

- Consult the manufacturer of any personal medical devices, such as pacemakers or hearing aids, to determine if they are adequately shielded from external RF (radio frequency) energy. DECT features operate between 1.88 GHz and 1.90 GHz with a peak transmission power of 250 mW.
- Do not use the product in health care facilities if any regulations posted in the area instruct you not to do so. Hospitals or health care facilities may be using equipment that could be sensitive to external RF energy.

CR Lithium battery

- Do not recharge, disassemble, remodel, heat or throw it into fire.
- Do not touch the terminals \oplus and \ominus with metal objects.
- Risk of explosion if battery is replaced by an incorrect type. Dispose of used battery according to local regulations.
- If any electrolyte should come into contact with your hands or clothes, wash it off thoroughly with water.
- If any electrolyte should come into contact with your eyes, never rub your eyes. Rinse your eyes

thoroughly with water, and then consult a doctor.

CAUTION

CR Lithium battery

- Use only the battery noted on page 3.
- Insert the battery correctly.
- Do not leave the battery in an automobile exposed to direct sunlight for a long period of time with the doors and windows closed.
- Remove the battery if you do not use the product for a long period of time. Keep it in a cool, dark area.
- Do not replace a battery with wet hands.
- Keep out of the reach of small children. There is a risk of swallowing. If the battery is swallowed, seek medical attention immediately.
- Remove the battery if it becomes unusable. There is a risk of leakage, overheating, and rupture. Do not attempt to use a battery if it is leaking.
- Exercise care when handling the batteries. Do not allow conductive materials such as rings, bracelets, or keys to touch the batteries, otherwise a short circuit may cause the batteries and/or the conductive material to overheat and cause burns.
Do not intentionally pour water on the battery or allow it to get wet. There is a risk of fire and smoke. If the battery becomes wet, remove it immediately and contact an authorised service centre.

Important safety instructions

When using your product, basic safety precautions should always be followed to reduce the risk of fire, electric shock, and injury to persons, including the following:

1. Do not use this product near water for example, near a bathtub, washbowl, kitchen sink, or laundry tub, in a wet basement or near a swimming pool.
2. Use only the batteries indicated in this document. Do not dispose of batteries in a fire. They may explode. Check with local codes for possible special disposal instructions.

SAVE THESE INSTRUCTIONS

For best performance

Hub location/avoiding noise

The hub and other compatible Panasonic devices use radio waves to communicate with each other.

- For maximum coverage and noise-free communications, place your hub:
 - at a convenient, high, and central location with no obstructions between the product and hub in an indoor environment.
 - away from electronic appliances such as TVs, radios, personal computers, wireless devices, or other phones.
 - facing away from radio frequency transmitters, such as external

Important Information

antennas of mobile phone cell stations. (Avoid putting the hub on a bay window or near a window.)

- If the reception for a hub location is not satisfactory, move the hub to another location for better reception.

Environment

- Keep the product away from electrical noise generating devices, such as fluorescent lamps and motors.
- The product should be kept free from excessive smoke, dust, high temperature, and vibration.
- The product should not be exposed to direct sunlight.
- Do not place heavy objects on top of the product.
- The product should be kept away from heat sources such as radiators, cookers etc. It should not be placed in rooms where the temperature is less than 0 °C or greater than 40 °C.
- Operating the product near electrical appliances may cause interference. Move away from the electrical appliances.

Other information

CAUTION: Risk of explosion if battery is replaced by an incorrect type. Dispose of used batteries according to the instructions.

Routine care

- Wipe the outer surface of the product with a soft moist cloth.
- Do not use benzine, thinner, or any abrasive powder.

Disposal of Old Equipment and Batteries (Only for European Union and countries with recycling systems)

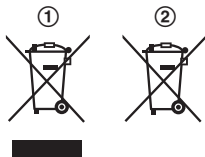

These symbols (①, ②) on the products, packaging, and/or accompanying documents mean that used electrical and electronic products and batteries must not be mixed with general household waste.

For proper treatment, recovery and recycling of old products and used batteries, please take them to applicable collection points in accordance with your national legislation.

By disposing of them correctly, you will help to save valuable resources and prevent any potential negative effects on human health and the environment. For more information about collection and recycling, please contact your local municipality.

Penalties may be applicable for incorrect disposal of this waste, in accordance with national legislation.

For business users in the European Union

If you wish to discard electrical and electronic equipment, please contact your dealer or supplier for further information.

Information on Disposal in other Countries outside the European Union

These symbols (①, ②) are only valid in the European Union. If you wish to discard these items, please contact your local authorities or dealer and ask for the correct method of disposal.

Note for the battery symbol

This symbol (②) might be used in combination with a chemical symbol. In this case it complies with the requirement set by the Directive for the chemical involved.

Note for the battery removal procedure

Refer to “Inserting the battery” on page 10.



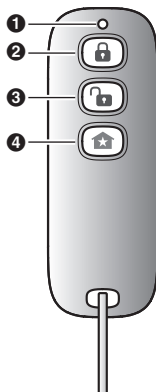

Part names and functions

■ Front view

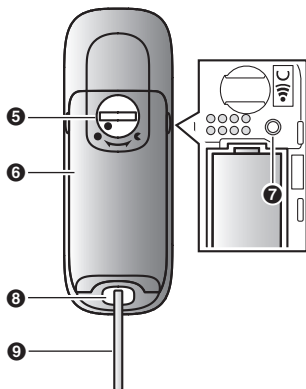

■ Rear view



- 1 LED indicator
- 2  (Arm: Away) button
Arms the alarm system using the **[Arm: Away]** mode.
- 3  (disarm) button
Disarms the alarm system.
- 4  (smart) button
Used to turn on a smart plug, trigger the alarm system, etc.
- 5 Battery cover lock
- 6 Battery cover
- 7  **[••)C]**
Used to register the keychain remote to the hub.
- 8 Key ring eyelet
- 9 Key ring

LED indicator

You can use the LED indicator to confirm the remote's status.

Indicator	Status
Off	Normal operation or no power ^{*1}
Amber, blinking quickly	Signal is being sent to the hub (you are pressing a button) ^{*2}
Red, lit	[Arm: Away] mode selected (you pressed the arm button) ^{*2}
Green, lit	[Disarm] mode selected (you pressed the disarm button), or you pressed the smart button ^{*2}

Indicator	Status
Red, blinking	Remote is out of range of the hub, or could not communicate with the hub
Green, blinking slowly	Registration mode (you pressed and held [••]C)
Repeating pattern of blinking green and blinking red	Low battery

- *1 The LED lights for about 2 seconds after a button is pressed, then turns off. If the LED indicator does not light when you press a button, the battery must be replaced.
- *2 The LED indicator does not indicate remote's status if the remote has not been registered (page 11).

4 Confirm the usage area

Read the information in this document to confirm that the desired usage area is suitable to proper operation.

Setup overview

1 Initial setup

Make sure you can access the system using your mobile device. For details, refer to the System Setup Guide included with your hub.

2 Insert the battery

The remote is battery powered.

3 Registration

Required only if the remote was purchased separately (i.e., not as part of a bundle).

Inserting the battery

- USE ONLY a CR2 Lithium battery.
 - Confirm the polarities (+, -).
 - Using a metal object to open the lock may scratch the lock.
- 1 Remove the battery cover.
- Insert a thin, flat object into the battery cover lock and rotate it to the "unlocked" position, as shown below.



Locked



Unlocked

- Grasp the indented areas on the sides of the battery cover (①) and lift the cover up (②).

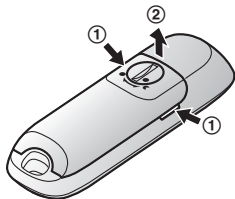

- 2 Insert the battery.

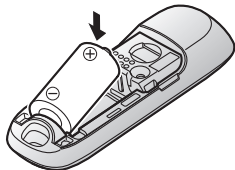

- 3 Attach and lock the battery cover.
- After attaching the battery cover, rotate the lock to the "locked" position.

Attaching the key ring

Attach the key ring to the remote as shown.



Registering the remote

This procedure is not required for devices that were included as part of a bundle.

Before you can use the remote, it must be registered to the hub.

If you purchased devices separately (i.e., not as part of a bundle), you must register each device to the hub.

You can register each device by using the registration buttons or the **[Home Network]** app.

Using registration buttons

1 Hub:

Press and hold **[••)C OTHER DEVICE]** until the LED indicator blinks slowly in green.

2 Remote:

Open the battery cover (page 10), then use an object with a thin tip, press and hold **[••)C]** until the LED indicator blinks slowly in green (page 8).

- When registration is complete, the hub sounds one long beep.

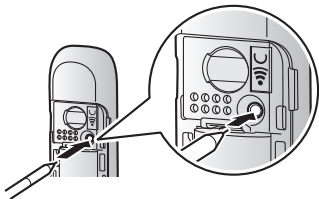

Note:

- To cancel without registering the remote, press **[••)C]** on the hub and on the remote again.
- If registration fails, the hub sounds several short beeps.

Using the app

When you register the remote by using the **[Home Network]** app, you can assign a name to your devices. For more information, refer to the User's Guide (page 12).

Wireless communication range

The wireless communication range of each device in the system from the hub is approximately 50 m indoors and approximately 300 m outdoors.

Wireless communication may be unreliable when the following obstacles are located between the hub and other devices.

- Metal doors or screens
- Walls containing aluminum-sheet insulation
- Walls made of concrete or corrugated iron
- Double-pane glass windows
- Multiple walls
- When using each device on separate floors or in different buildings



Using the remote

Changing the arm mode

Press the desired arm mode button.

- The LED indicator lights for about 2 seconds according to the arm mode (page 8).
- When the arm mode is changed with the keychain remote, the arm mode icons displayed on the app will not be automatically changed. The displayed arm mode icons will be updated when the app refreshes the home screen.

Canceling an alert

When the hub is sounding an alert, you can press  or  on the

keychain remote to cancel the alert.

- When the keychain remote cancels the alert, the LED indicator lights for about 2 seconds.

Using the smart button

You can press the keychain remote's smart button to turn on a smart plug, trigger the alarm system, etc.

Use the **[Home Network]** app to change the feature assigned to the smart button. For more information, refer to the User's Guide (page 12).

Features available when using the [Home Network] app

Some of the features that are available when using the **[Home Network]** app are listed below. For more information, refer to the User's Guide (page 12).

- **Alarm system**
You can use the app to arm and disarm the alarm system.
- **Device management**
You can use the app to change the remote's name and assign a feature to the keychain remote's smart button.

Accessing the User's Guide

The User's Guide is a collection of online documentation that helps you get the most out of the **[Home Network]** app.

1 iPhone/iPad

Tap  in the app's home screen.

Android™ devices

Tap  or press your mobile device's menu button in the app's home screen.

2 Tap [User's Guide].

Note:

- Microsoft® Windows® Internet Explorer® 8 and earlier versions are not supported.
- Android 4.1 or later versions are recommended.

- You can also access the User's Guide at the web page listed below.



www.panasonic.net/pcc/support/tel/homenetwork/manual/

Specifications

- **Standards**
DECT (Digital Enhanced Cordless Telecommunications)
 - **Frequency range**
1.88 GHz – 1.90 GHz
 - **RF transmission power**
Approx. 10 mW (average power per channel)
250 mW (max.)
 - **Power source**
Lithium battery CR2 (CR15H270)
(1 × 3.0 V, 850 mAh)
 - **Operating conditions**
0 °C – 40 °C
 - **Battery life**
Approx. 2 years (when the remote is used 10 times a day, in an environment of 25 °C)*1
 - **Dimensions (height × width × depth)**
77 mm × 27 mm × 18 mm
(without the key ring attached)
 - **Mass (weight)**
Approx. 17 g, excluding the battery and without the key ring attached
- *1 Battery life may be reduced depending on the operating environment, and whether the remote is used when it is out of range of the hub.

For your future reference

We recommend keeping a record of the following information to assist with any repair under warranty.

Serial No.	Date of purchase
(found on the product's carton box)	
Name and address of dealer	

Attach your purchase receipt here.

Panasonic Corporation

1006, Oaza Kadoma, Kadoma-shi, Osaka 571-8501, Japan

<http://www.panasonic.com>

© Panasonic Corporation 2016