

## Important Information and Quick Guide

Model Name	Model No.
<b>Video Intercom System</b>	<b>VL-SV71 VL-SV72</b>
<b>Main Monitor Station</b>	<b>VL-MV71 VL-MV72</b>

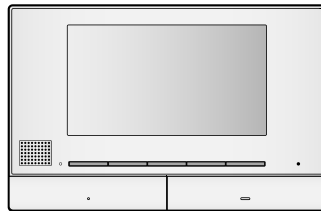

### Table of Contents

1. Introduction	2
2. Important information	5
3. Preparation	8
4. Basic operations	10
5. Additional functions	12
6. VL-V900 basic operations	13
7. Specifications	15

Thank you for purchasing a Panasonic product.

Please read this document before using the product and save it for future reference.

Carefully read the information found in the section titled "For your safety" in particular.

**For further information about features and operations, visit our Web site and find the document:**

**<https://panasonic.net/cns/pcc/support/intercom/sv71>**

**Installation Guide is supplied separately.**

This system is an auxiliary system; it is not designed to provide complete protection from property loss. Panasonic will not be held responsible in the event that property loss occurs while this system is in operation.

## 1. Introduction

---

### 1.1 Model composition

Model composition	Main Monitor Station *1 (Main monitor*2)	Door Station (Doorphone*2)
VL-SV71	VL-MV71	VL-V522L
VL-MV71	VL-MV71	-
VL-SV72	VL-MV72	VL-V522L
VL-MV72	VL-MV72	-

\*1 Can be configured to be used as an extension monitor.

\*2 Product names used in this document.

**Caution:**

- **Before attempting to connect or operate this product, please read the label on the rear of the main monitor.**

---

### 1.2 Accessory information

#### 1.2.1 Supplied accessories

**Note:**

- Accessories for installing the main monitor and the doorphone are described in the supplied Installation Guide.

## 1.3 General information

- In the event of problems, you should contact your equipment supplier in the first instance.
- The available products differ depending on your region. For more information, please consult your dealer.
- In this document, the suffix of each model number (e.g., the "BX" in "VL-SV71BX") is omitted unless necessary. When the suffixes are used to describe models (e.g., "BX models"), the suffixes refer to all models in the series.
- Design and specifications are subject to change without notice.
- The illustrations in the supplied document may vary slightly from the actual product.

### House mode and Apartment mode

The main monitor can be configured to be used in two modes: House mode and Apartment mode.

- House mode refers to when the main monitor is used as a stand-alone system and is not connected to a larger system comprised of a VL-V900 lobby station. This document describes the operations for House mode.
- Apartment mode refers to when the main monitor is used connected to a larger system comprised of a VL-V900 lobby station, such as in apartment complexes. Operations for Apartment mode are described in 6. VL-V900 basic operations (Page 13) of this document.

For further information about features and operations, visit our Web site and find the document:

<https://panasonic.net/cns/pcc/support/intercom/v900>

### For Europe

#### Contact to Authorised Representative:

Panasonic Testing Centre

Panasonic Marketing Europe GmbH

Winsbergring 15, 22525 Hamburg, Germany

### Ecodesign information

Ecodesign information under EU Regulation (EC) No. 1275/2008 amended by (EU) Regulation No. 801/2013. From 1 January 2015.

Please visit here: [www.ptc.panasonic.eu/erp](http://www.ptc.panasonic.eu/erp)

Click [Downloads]

→ Energy related products information (Public)

Power consumption in networked standby and guidance are mentioned in the Web site above.

This device is classified as a HiNA device (networked equipment with high network availability), according to Ecodesign requirements.

### Graphical symbols for use on equipment and their descriptions











1		2		3		4		5		6	
7		8		9		10		11		12	

1. Alternating current (A.C.) 2. Direct current (D.C.) 3. Protective earth 4. Protective bonding earth 5. Functional earth 6. For indoor use only 7. Class II equipment (equipment in which protection against electric shock relies on Double Insulation or Reinforced Insulation) 8. "ON" (power) 9. "OFF" (power) 10. Stand-by (power) 11. "ON"/"OFF" (power; push-push) 12. Caution, risk of electric shock

## 1. Introduction

### 1.4 Symbols, expressions, and styles

The following symbols, expressions, and styles are used in this document.

Item	How it is expressed	Example
Text displayed on the product's display	Text is displayed in a special font, usually enclosed in quotation marks	"Initial settings"
Icons displayed on the product's display	Black-and-white illustration of icon is used	
Buttons with printing on them or near them	Button printing is displayed, usually wrapped in thick brackets	【TALK】 【  】
Soft keys	Black-and-white illustration of the corresponding soft key icon is used	
Procedures	Usually written in an abbreviated style. The verb may be omitted. Unless otherwise stated, all procedures are for both the main monitor and extension monitor.	<b>Main monitor/extension monitor example</b>  → "Display" →  → "Brightness" ● <b>Meaning:</b> Press the soft key under the displayed  soft key icon, press the soft keys under the displayed  and  soft key icons to select "Display", press the soft key under the displayed  soft key icon, and then press  or  to select "Brightness".

### 1.5 Trademarks and registered trademarks

- The software of this product is based in part on the work of the Independent JPEG Group.
- All other trademarks identified herein are the property of their respective owners.

---

### 2.1 For your safety

To prevent severe injury and loss of life/property, read this section carefully before using the product to ensure proper and safe operation of your product.



#### WARNING

##### Preventing fire and electric shock

- Use only the power source marked on the product. If you are not sure of the type of power supplied to your home, consult your dealer or local power company.
- Use only the specified power supply unit and AC cable.
- Do not attempt to disassemble or modify this product. Contact an authorised service centre for repairs.
- Never touch the power supply unit, AC cable, and power plug with wet hands.
- Do not touch the power supply unit, AC cable, and power plug during an electrical storm.
- Do not use the product (excluding the doorphone) in areas that are exposed to rain, moisture, steam, or oily smoke, or areas that have excessive dust.
- Do not perform any actions (such as fabricating, twisting, stretching, bundling, forcibly bending, damaging, altering, exposing to heat sources, or placing heavy objects on the power cable) that may damage the power cable. Using the product with a damaged power cable may cause electric shock, short circuits, or fire. Contact an authorised service centre for repairs.
- Do not overload the power outlet or wiring above the specified levels. Overloading by having many connections on one power outlet may cause heat generation, resulting in a fire.
- Never put metal objects inside the product. Never spill any liquid on the product (excluding the doorphone).  
If metal objects enter the product or the product becomes wet, unplug the product from the power outlet and contact an authorised service centre.
- Do not use a microwave oven or other devices, such as electromagnetic cookers, to speed up the drying process of any parts of the product.
- Completely insert the AC cable plug and power plug into the power outlets. Failure to do so may cause electric shock and/or excessive

heat resulting in a fire. Do not use damaged AC cable plug, power plug, or power outlets.

- Regularly remove any dust, etc., from the AC cable plug and power plug by unplugging them from the power outlets, then wiping them with a dry cloth. Accumulated dust may cause an insulation defect from moisture, etc., resulting in a fire.
- Unplug the product from the power outlet if the product emits smoke, an abnormal smell or makes unusual noise, or if the product has been dropped or physically damaged. These conditions can cause fire or electric shock. Confirm that smoke has stopped emitting and contact an authorised service centre.
- Hold the main body (not the metal parts) of the AC cable plug and power plug when unplugging them. Unplugging the AC cable plug and power plug while holding their cords or cords' plugs may result in fire, electric shock, or injury.



#### CAUTION

##### Preventing accidents, injuries, and property damage

- Do not use the product in unstable areas or areas prone to strong vibrations. This may cause the product to fall, resulting in damage to the product or injury.
- Do not put your ear(s) near the speaker, as loud sounds emitted from the speaker may cause hearing impairment.

---

### 2.2 Important safety instructions

When using this product, basic safety precautions should always be followed to reduce the risk of fire, electric shock, or personal injury.

1. Do not use this product near water. For example, near a bathtub, wash bowl, kitchen sink, or laundry tub, in a wet basement, or near a swimming pool, etc.
2. Use only the power cable, power supply unit, and AC cable indicated in this document.

#### SAVE THESE INSTRUCTIONS

---

### 2.3 For best performance

##### Environment

- Keep the unit away from electrical noise generating devices, such as fluorescent lamps and motors.
- The unit should not be exposed to direct sunlight.

## 2. Important information

---

- The unit should be kept away from heat sources such as radiators, cookers, etc. It should not be placed in rooms where the temperature is less than 0 °C or greater than 40 °C. Damp basements should also be avoided.
- Do not install the product in locations that are suspect to sudden changes in temperature. Failure to do so may cause condensation to form on the product causing malfunction.
- In areas surrounded by a high electrical field, disturbances may occur in the unit's image or sound.

---

## 2.4 Other important information

- The AC cable plug and power plug are used as the main disconnect device. Ensure that the power outlet is installed near the product and is easily accessible.

### Privacy and rights of portrait

When installing or using the doorphone, please take into consideration the rights of others with regard to privacy.

- It is generally said that "privacy" means the ability of an individual or group to stop information about themselves from becoming known to people other than those whom they choose to give the information. "Rights of portrait" means the right to be safe from having your own image taken and used indiscriminately without consent.

### Personal information

The main monitor's/extension monitor's internal memory records personal information (image and audio recordings of visitors, etc.). Panasonic assumes no liability for any unforeseen damages arising from the exposure of the recorded information.

- **Disclaimer**

Recorded data may be altered or deleted as a result of incorrect operations, exposure to static electricity, accidents, malfunction, repairs or other operations. Panasonic assumes no liability for any direct or indirect damages resulting from the loss or alteration of recorded images.

### Requesting repairs for the product

- Before submitting the main monitor/extension monitor for repair, initialize them. This will delete all information saved in the main monitor/extension monitor.\*1
- Even if the product is sent for repairs without being initialized, the memory (including recorded data and settings) for the main monitor/extension monitor may be cleared and set to factory default after repair.
- If operations cannot be performed due to the main monitor/extension monitor malfunction, consult with the place of purchase for appropriate action.

### Note for product disposal, transfer, or return

- This product can store your private/confidential information.

To protect your privacy/confidentiality, we recommend that you erase the information (recorded images) from the memory before you dispose of, transfer or return the product.

All the recorded images can be erased at once by initializing the main monitor/extension monitor.\*1

- \*1 Main monitor/extension monitor: perform "Factory Setting" in "Initialize settings".

---

### Information on Disposal in other Countries outside the European Union



Above symbol (①) is only valid in the European Union. If you wish to discard this product, please contact your local authorities or dealer and ask for the correct method of disposal.

---

### Others

- It is prohibited to disassemble or modify this product. Contact the dealer where you purchased this product for repair.
- When power fails, this product cannot be used.
- For the recorded image:  
The recorded image may be lost when:
  - Mishandled
  - Electric shock occurs.
  - The power is turned off during use.
- Panasonic may not be liable for damages due to external factors such as power failures.
- If you stop using the main monitor/extension monitor and the doorphone, remove the main monitor/extension monitor and the doorphone from the walls to prevent them from falling off. (Consult your dealer for information about removing the product.)

---

## 2.5 For India only

### Declaration of Conformity with the requirements of the E-Waste (Management) Rules

The Product is in conformity with the requirements of the reduction of hazardous substances of the E-Waste Rules.

The content of hazardous substance with the exemption of the applications listed in SCHEDULE II of the E-Waste Rules:

1. Lead (Pb) – not over 0.1% by weight;
2. Cadmium (Cd) – not over 0.01% by weight;
3. Mercury (Hg) – not over 0.1% by weight;

4. Hexavalent chromium (Cr6+) – not over 0.1% by weight;
5. Polybrominated biphenyls (PBBs) – not over 0.1% by weight;
6. Polybrominated diphenyl ethers (PBDEs) – not over 0.1% by weight.

---

### Disposal information



For the purpose of recycling to facilitate effective utilization of resources, please return this product to a nearby authorized collection centre, registered dismantler or recycler, or Panasonic service centre when disposing of this product.

Please see the Panasonic website for further information on collection centres, etc., or call the toll-free number below.

Website:

<http://www.panasonic.com/in/corporate/sustainability/panasonic-india-i-recycle-program.html>

Service helpline: 1800 103 1333 or 1800 108 1333

---

---

## 2.6 Cleaning

Wipe the product with a soft, dry cloth.

For excessive dirt, wipe the product with a moist cloth.

### Important:

- **Do not use any cleaning products that contain alcohol, polish powder, powder soap, benzine, thinner, wax, petroleum, or boiling water. Also do not spray the product with insecticide, glass cleaner, or hair spray. This may cause a change in colour or quality of the product.**

## 3. Preparation

### 3.1 Controls

#### 3.1.1 Doorphone

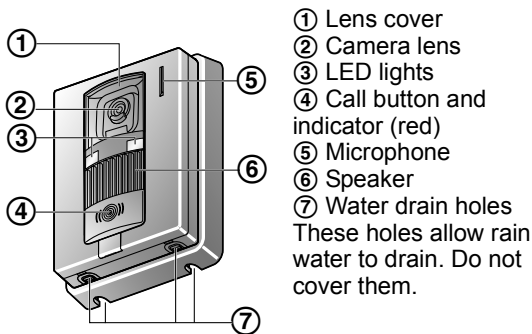

#### 3.1.2 Main monitor/extension monitor

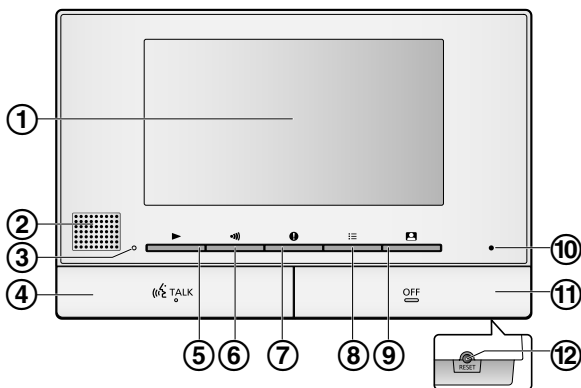

① Display (page 8)

② Speaker

③ Play lamp (blue)

④ TALK button ([TALK])

⑤ Play button ([▶])

⑥ Page button ([⏪])

Press to page extension monitors when the main monitor is idle or transfer calls.

⑦ Information button ([!])

⑧ Menu button ([☰])

⑨ Monitor button ([📺])

⑩ Microphone

⑪ OFF button ([OFF])

⑫ RESET button

If the main monitor cannot be correctly operated, press the **[RESET]** button with a pointed object to reset the main monitor. (Recorded images and configured settings are not affected.)

#### Soft keys

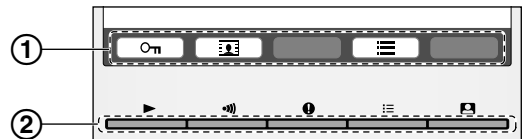

① Soft key icons, ② Soft keys

Icons indicate the functions that can be operated by the soft keys.

### 3.2 Using the display

#### 3.2.1 Main monitor - display information

##### Image viewing screen

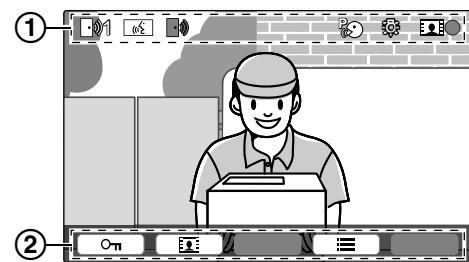

① Status icons (page 8)

② Soft key icons (page 8)

##### Status icons (main monitor)



Indicates which doorphone is calling, monitoring, or on a call. ("1" indicates the device number.)



Indicates there is a call from the doorphone when monitoring or on a call with another device.



Indicates that the main monitor is on a call.



Indicates that a doorphone and a PBX extension are talking.



Indicates that the main monitor is monitoring.



Indicates that images are being recorded.



Indicates that the doorphone's LED lights are on.











Indicates that "Press-to-talk" mode is on.



---

## 3.3 Setting the language, date and time

- The play lamp lights if these settings are not configured.
- 1 Press the  button to turn on the display.
  - 2 Press  or  to select the desired language.
  - 3 Press .
  - 4 Press  again.
  - 5 Set the date and time.
    - Press  to select an item (i.e., year, month, day, etc.).
    - Press  or  to change the setting.
  - 6 When finished, press .

**Note:**

- The date and time settings may be deleted when there is a power outage. In this case, reconfigure the settings.
- The time may become out of sync over time (about 60 seconds per month).

## 4. Basic operations

---

### 4.1 Answering doorphone calls

When you receive a call from a doorphone, the main monitor and extension monitor ring, and display an image from the doorphone.

#### To answer the call

Press **[TALK]**.

- Speak within about 50 cm of the microphone.
- Speak alternatively with the visitor. If you and the visitor speak at the same time, you will not hear each other.
- You can talk for up to about 90 seconds.

#### To end the call

Press **[OFF]**.

---

### 4.2 Talking with other devices

You can make intercom calls between the main monitor and extension monitor.

#### To make a call

1. Press **[CALL]**.
  2. If there are multiple devices, select the device to page → **[OK]**.
    - To page all devices, select “Call all together” → **[OK]**.
  3. Page the other party.
  4. Talk with the paged party when they answer the call.
  5. When finished, press **[OFF]**.
- 

#### To receive a call

1. When the intercom call is received, press **[TALK]** to talk to the paging party.
  2. When finished, press **[OFF]**.
- 

### 4.3 Monitoring the outside with the doorphone

You can monitor the sounds and images from the doorphone using the main monitor and extension monitor.

1. Press **[MONITOR]**.
    - If there are multiple doorphones, select the desired doorphone → **[OK]**.
    - The images from the doorphone are displayed.
  2. Monitor the sound and image.
    - You can talk to the monitored party by pressing **[TALK]**.
  3. When finished, press **[OFF]**.
- 

### 4.4 Recording automatically (recording a received call)

The main monitor and extension monitor can record doorphone images (still images). They can save images from up to 50 doorphone calls or monitoring sessions. Each time new images are recorded, they are saved in an image set of up to 8 images.

When a visitor calls you, the main monitor and extension monitor record 8 images automatically (whether you answer the call or not). Recording starts about 2 seconds after you receive the call.

---

#### When you do not answer a call

The recorded images are saved as unplayed images, and the play lamp lights.

---

#### When there are multiple doorphones

- When you are talking or monitoring and there is an incoming call from another doorphone, images from the incoming call will not be displayed and recorded. In order to display and record incoming calls, you must end the current call or stop monitoring.
  - If there is an incoming call from another doorphone, while receiving an incoming call, the number of recorded images from the 1st caller (8 images) are reduced.
- 

#### When the memory is full (auto image updating)

When the memory is full, new images overwrite the oldest images automatically. This occurs even if the oldest images are unplayed images.

---

### 4.5 Recording manually (recording while monitoring)

The main monitor and extension monitor can manually record 8 images while monitoring.

While monitoring, press **[RECORD]**.

---

### 4.6 Playing recorded images







When there are new (i.e., unplayed) images recorded, the play lamp (page 8) lights.

1. Press **[PLAY]**.
  - “Recorded image list” screen is displayed.
2. Select “Unplayed images” (for new images) or “Played images” (for images that have been played) → **[OK]**.
  - The most recent image set of the selected type is displayed.
3. Browse the image sets and images.
  - The following operations are available.



Plays back all images in an image set continuously

---

-  Browses image sets, from older ones to newer ones
-  Browses image sets, from newer ones to older ones
-  Displays the options menu
-  Returns to the previous screen
-  Pauses continuous playback
-  Plays the previous image in an image set when continuous play is paused
-  Plays the next image in an image set when continuous play is paused

4 When finished, press **[OFF]**.

---

## 4.7 Using electric locks

When a commercially available electric lock is connected to the main monitor, you can unlock a door or gate using the main monitor.

- For detailed information about connections, see the operating instructions included with the electric lock and the Installation Guide of this product.

---

### 4.7.1 Configuring electric locks

- 1 Press **[☰]**.
- 2 Select “Connected devices” → **[OK]**.
- 3 Select “Electric lock” → **[OK]**.
- 4 Select the doorphone (“Doorphone 1” or “Doorphone 2”) that you want to assign the electric lock to → **[OK]**.
- 5 Select the type of the electric lock → **[OK]**.
- 6 Select the device that the electric lock is connected to → **[OK]**.
- 7 Select the unlocking time → **[OK]**.
- 8 When finished, press **[OFF]**.

---

### 4.7.2 Unlocking electric locks

- 1 Press **[On]** while talking or monitoring.
  - If there are 2 electric locks available, select the electric lock to be unlocked → **[OK]** → press **[On]** to unlock another electric lock.

**Note:**

- When using multiple electric locks with different doorphones, you can only operate the locks from the doorphone that they are connected to.

---

### 5.1 Function settings

You can change the settings, such as Initial settings, Ringtone settings, and Connected devices settings, to match how your product is used. You can also view information on how to access the Operating Instructions.

- 1 Press **[☰]**.
- 2 Select the desired item → **[OK]**.
  - Repeat this step as necessary to navigate to the desired setting.
- 3 Select the desired setting → **[OK]**.
- 4 Press **[OFF]**.

---

### 5.2 Registering devices

#### 5.2.1 Registering extension monitors

##### 1 Main monitor:

Press **[☰]** → select “Register/Cancel” → **[OK]**.

- 2 Select “Register” → **[OK]**.
  - When you are prompted to register your main monitor, select “Main monitor” → **[OK]**.
- 3 Select the registration number of the extension monitor to be registered → **[OK]**.

##### 4 Extension monitor:

Press **[☰]** → select “Register/Cancel” → **[OK]**.

- 5 Select “Register” → **[OK]**.
  - When you are prompted to register your extension monitor, select “Extension monitor” → **[OK]** → **[Yes]**.
- 6 Select the registration number of the extension monitor to be registered → **[OK]**.
  - Make sure to select the same registration number that was selected on the main monitor.
  - Registration is complete when the extension monitor restarts.

##### 7 Main monitor:

Press **[OFF]**.

This section explains the basic operations of the VL-V900 lobby station (Video Intercom System for Apartment Complexes) when used with the VL-MV71 and VL-MV72 main monitors.

For further information about features and operations, visit our Web site and find the document:

<https://panasonic.net/cns/pcc/support/intercom/v900>

## 6.1 Controls

### 6.1.1 Lobby station

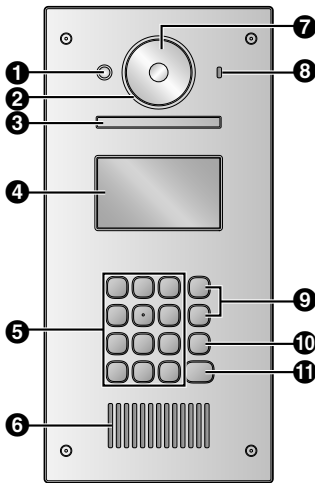

- 1 Heat sensor**  
Turns on the display when a visitor is detected.
- 2 Lens cover**
- 3 Light**  
Illuminates subjects in dark environments.
- 4 Display**
- 5 Keypad**
- 6 Speaker**
- 7 Camera lens**
- 8 Microphone**
- 9 Search buttons (▲ and ▼)**  
Used to select items shown on the display.
- 10 Cancel button (X)**
- 11 Call button (△)**

## 6.2 Lobby station operations

### 6.2.1 Calling a resident

#### Entering a room number

1. Enter the resident's room number.
2. Press [△] to call.

#### Searching by first letter of the name

1. Press [✱].
2. Use the keypad to enter the first letter of the resident's name.
  - Press a key repeatedly to scroll through the letters assigned to that key.
  - Note the hints displayed at the bottom of the screen.
3. Press [▲] or [▼] to search for the desired name.
4. Press [△] to call.

#### Searching through all names

1. Press [▼].
2. Press [▲] or [▼] to search for the desired name.
3. Press [△] to call.

#### Switching the image displayed on the main monitor

While talking to the main monitor, press [#] to switch the image displayed on the main monitor from the lobby

station to the camera. To return to the lobby image, press [✱].

### 6.2.2 Calling a receptionist





1. Press [▼].
2. Press [▲] or [▼] to search for the receptionist.
3. Press [△] to call.

### 6.2.3 Opening the door by entering an unlock code

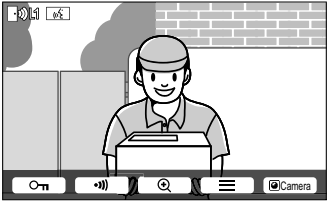
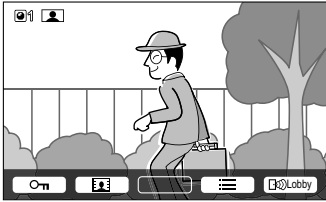

1. Press [#].
2. Enter the 4-digit unlock code.
3. Press [△].

### 6.3 Main monitor operations with the lobby station

#### 6.3.1 Image viewing screen of the main monitor

Image from lobby station	Image from camera	Status icons
		<ul style="list-style-type: none"><li> Indicates which lobby station is calling, monitoring, or talking. ("1" indicates the device number.)</li><li> Indicates which camera is monitoring. ("1" indicates the device number.)</li><li> Indicates that the main monitor is talking.</li><li> Indicates that the main monitor is monitoring.</li></ul>

#### 6.3.2 Monitoring the outside with the lobby station or camera

- 1 Press **[]**.
  - If there are multiple devices, select the desired device → **[OK]**.
  - If a camera is connected to the lobby station, you can alternate monitoring between the lobby station and camera by pressing **[Camera]** or **[Lobby]**.
- 2 When finished, press **[OFF]**.

**Note:**

- Depending on the composition of the system, monitoring may not be available.

#### 6.3.3 Opening entrance doors

While talking to a visitor or monitoring with a lobby station or camera, press **[]**.

#### 6.3.4 Calling extension telephones

- 1 Press **[ TALK]**.
- 2 Select the desired extension telephone.
  - Up to 4 extension telephones may be displayed.
- 3 Press **[OK]** → **[Yes]**.
- 4 When finished, press **[OFF]**.

### 6.4 System conditions and limitations

Please note the following system conditions and limitations.

- Only one call or monitoring session can be handled at a time.  
Subsequent calls will disconnect the current call (if the current call has lower priority), or will not be connected (if the current call has higher priority).  
Low priority: Monitoring  
Medium priority: General calls (lobby station to main monitor, main monitor to PBX extension, etc.)  
High priority: Emergency calls
- All calls and monitoring sessions are disconnected after the pre-programmed "timeout" time elapses.
- In order to perform the above operations, optional devices and configuration for those devices are required. Contact your building manager for more information.

## 7.1 Specifications

### Main monitor (VL-MV71/VL-MV72)

<b>Power source</b>	<ul style="list-style-type: none"> <li>VL-MV71: 220-240 V AC, 50/60 Hz</li> <li>VL-MV72: power supply unit (VL-PS241) 24 V DC, 0.4 A</li> </ul>
<b>Power consumption</b>	<ul style="list-style-type: none"> <li>VL-MV71: Standby: 2.0 W During operation: 10.5 W</li> <li>VL-MV72: Standby: 1.6 W During operation: 9.8 W</li> </ul>
<b>Dimensions (mm) (height × width × depth)</b>	Approx. 158×243×29.5 (excluding protruding sections)
<b>Mass (weight)</b>	<ul style="list-style-type: none"> <li>VL-MV71BX: approx. 825 g</li> <li>VL-MV71CX/ML: approx. 875 g</li> <li>VL-MV71SX: approx. 850 g</li> <li>VL-MV71AZ: approx. 835 g</li> <li>VL-MV72AZ: approx. 710 g</li> </ul>
<b>Operating environment</b>	Ambient temperature: approx. 0 °C to +40 °C Relative humidity (non-condensing): up to 90 %
<b>Display</b>	Approx. 17.8 cm (7.0 inches wide colour display)
<b>Talking method</b>	Hands-free
<b>Installation method</b>	Wall mount (mounting bracket supplied)

### Power supply unit (VL-PS241) (indoor use only)

<b>Power source</b>	Input: 220-240 V AC, 0.2 A, 50/60 Hz Output: 24 V DC, 0.6 A
<b>Dimensions (mm) (height × width × depth)</b>	Approx. 104×100×54 (excluding protruding sections)
<b>Mass (weight)</b>	Approx. 215 g
<b>Operating environment</b>	Ambient temperature: approx. 0 °C to +40 °C Relative humidity (non-condensing): up to 90 %
<b>Installation method</b>	Attach to DIN rail

### Doorphone (VL-V522L)

<b>Power source</b>	Power supplied by the main monitor
<b>Dimensions (mm) (height × width × depth)</b>	Approx. 131×99×36.5 (excluding protruding sections)
<b>Mass (weight)</b>	Approx. 200 g
<b>Operating environment</b>	Ambient temperature: approx. -15 °C to +55 °C Relative humidity (non-condensing): up to 90 %
<b>Viewing angle</b>	Horizontally: approx. 87° Vertically: approx. 66°
<b>Installation method</b>	Wall mount (mounting base supplied)
<b>Minimum illuminance required</b>	1 lx (within approx. 50 cm from the camera lens)
<b>Lighting method</b>	LED lights

**Panasonic Corporation**

1006, Oaza Kadoma, Kadoma-shi, Osaka 571-8501, Japan  
<http://www.panasonic.com>

© Panasonic Corporation 2017



\*PNQX8539ZA\*

**PNQX8539ZA** C0517MM0