

## Operating Instructions

Model name	<b>Video Intercom System</b>	<b>Main Monitor Station</b>
Model No.	<b>VL-SVN511 series</b>	<b>VL-MVN511</b>

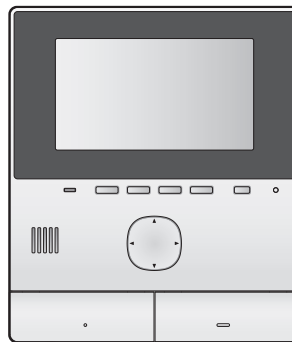

Thank you for purchasing a Panasonic product.

Please read this manual before using the product and save it for future reference.

---

This system is an auxiliary system; it is not designed to provide complete protection from property loss. Panasonic will not be held responsible in the event that property loss occurs while this system is in operation.

**Installation Guide is supplied separately.**

## 1. Introduction

### Introduction

1.1	Model composition .....	3
1.2	Accessory information .....	3
1.3	Additional/replacement accessories .....	3
1.4	General information .....	4
1.5	Symbols, expressions, and styles .....	5
1.6	Trademarks and registered trademarks .....	5
1.7	Open source software notice .....	5

## 2. Important information

### Important information

2.1	For your safety .....	6
2.2	Important safety instructions .....	6
2.3	Security cautions .....	6
2.4	For best performance .....	7
2.5	Other important information .....	7

## 3. Preparation

### Preparation

3.1	Controls .....	9
3.2	Using the display .....	10
3.3	Setting the language, date and time .....	11
3.4	Wide/zoom settings and zoom position settings .....	11

## 4. Talking and monitoring

### Talking and monitoring

4.1	Answering doorphone calls .....	12
4.2	Monitoring the outside with the doorphone .....	12

## 5. Recording and playing

### Recording and playing

5.1	Recording doorphone images .....	13
5.2	Playing recorded images .....	13

## 6. Using electric locks and other devices

### Using electric locks and other devices

6.1	Using electric locks .....	15
6.2	Using sensors .....	15
6.3	Panasonic PBX integration .....	15

## 7. Additional functions

### Additional functions

7.1	Zooming in and out (wide/zoom, pan/ tilt) .....	17
7.2	Sound and display settings for calls and monitoring .....	17
7.3	Ringtone settings .....	17
7.4	Function settings list .....	18

## 8. Wi-Fi, mobile devices, and email

### Wi-Fi, mobile devices, and email

8.1	Network connections .....	21
8.2	Entering text .....	21
8.3	Connecting to a Wi-Fi network .....	21
8.4	Using mobile devices .....	22
8.5	Using email features .....	23

## 9. General information

### General information

9.1	Cleaning .....	25
9.2	Specifications .....	25

## 10. Troubleshooting

### Troubleshooting

10.1	Troubleshooting .....	26
10.2	Error messages .....	28

## 11. Index

11.1	Index.....	30
------	------------	----

## 1.1 Model composition

Model composition	Main Monitor Station (Main monitor*1)	Door Station (Doorphone*1)
VL-SVN511	VL-MVN511	VL-V555
VL-MVN511	VL-MVN511	—

\*1 Product names used in this manual.

- In this manual, the suffix of each model number (e.g., the "EX" in "VL-SVN511EX") is omitted unless necessary.
- When the suffixes are used to describe models (e.g., "AZ models"), the suffixes refers to all models in the series.

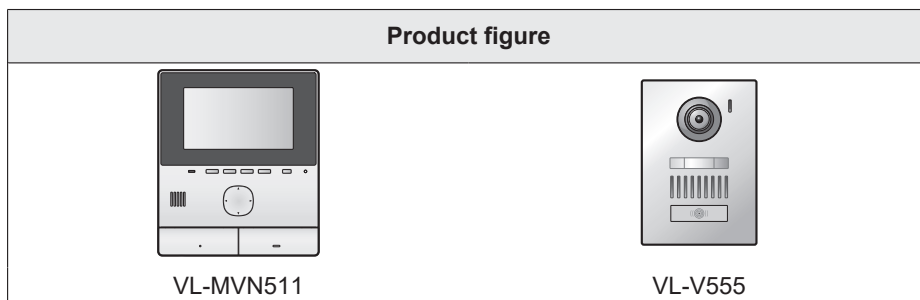

- The illustrations in the supplied manual(s) may vary slightly from the actual product.

### Caution:

- Before attempting to connect or operate this product, please read the label on the rear of the main monitor.

## 1.2 Accessory information

### 1.2.1 Supplied accessories

#### Note:

- Accessories for installing the main monitor and the doorphone are described in the supplied Installation Guide.

## 1.3 Additional/replacement accessories

Please contact your nearest Panasonic dealer for sales information.

As of November, 2015

Accessory item	Order number	Number of devices that can be connected
Door Station (referred to as "doorphone" in this document)	VL-V555 (surface mount)	Max. of 2, including the supplied devices
	VL-V554*1 (surface mount)	
	VL-V554U*1 (flush mount)	
	VL-V566*3,*4 (surface mount)	
	VL-V522L*3,*4 (surface mount)	
Lobby Station*2	VL-V590*3,*4 (for apartment complexes)	

\*1 EX and AZ models only

\*2 When using in a lobby, see the Installation Guide for details.

\*3 AZ models only

\*4 The specifications for the VL-V566, VL-V522L, and VL-V590 differ to the specifications for the supplied doorphone. Generally, functions listed in this manual as available for the doorphone are available for the supplied doorphone, VL-V566, VL-V522L, and VL-V590. However, the following functions are not available for the VL-V566, VL-V522L, and VL-V590.

## 1. Introduction

---

- VL-V590: Monitoring the outside with the doorphone (page 12)
- VL-V566/VL-V590: Doorphone LED lights' illumination settings (page 17)
- VL-V566/VL-V590: Doorphone backlight compensation settings (page 17)
- VL-V566/VL-V522L/VL-V590: Wide/zoom settings and zoom position settings (page 11)

---

### 1.3.1 Compatible Panasonic PBXs (AZ models only)

This unit can be used with Panasonic PBXs (page 15). Consult your dealer for more information.

#### Compatible Panasonic PBXs<sup>\*1</sup>

- KX-TDA30/TDA100/TDA100D/TDA200/TDA600 series
- KX-TDE100/TDE200/TDE600 series
- KX-NS300/NS500/NS700/NS1000 series
- KX-NSX1000/NSX2000 series

\*1 As of November, 2015.







---

## 1.4 General information

- In the event of problems, you should contact your equipment supplier in the first instance.

## 1.5 Symbols, expressions, and styles

The following symbols, expressions, and styles are used in this document.

Item	How it is expressed	Example
Text displayed on the product's display	Text is displayed in a special font, usually enclosed in quotation marks	"Initial settings"
Icons displayed on the product's display	Black-and-white illustration of icon is used	
Buttons with printing on them	Button printing is displayed, usually wrapped in thick brackets	【TALK】
Soft keys (page 9)	Black-and-white illustration of the corresponding soft key icon is used	
Navigator key (page 9)	Either referred to by name, or with a black-and-white illustration	<ul style="list-style-type: none"> <li>• "Use the navigator key to select..."</li> <li>• "Press  to select..."</li> <li>• "Select..."</li> </ul>
Text displayed by mobile device app	Text is enclosed in brackets	[Register]
Procedures	Usually written in an abbreviated style. The verb may be omitted.	<p>Top menu → select  → .</p> <p>(Meaning: From the top menu, use the navigator key to select  on the display, and then press the soft key under the  soft key icon.)</p>

## 1.6 Trademarks and registered trademarks

- The software of this product is based in part on the work of the Independent JPEG Group.
- Wi-Fi, WPA, and WPA2 are registered trademarks or trademarks of Wi-Fi Alliance.
- iPhone and iPad are trademarks of Apple Inc., registered in the U.S. and other countries.
- Android is a trademark of Google Inc.
- All other trademarks identified herein are the property of their respective owners.

## 1.7 Open source software notice

Parts of this product use open source software supplied based on the relevant conditions of the Free Software Foundation's GPL and/or LGPL and other conditions. Please read all licence information and copyright notices related to the open source software used by this product. This information is available at the following web page:

<http://panasonic.net/pcc/support/intercom/svn511/>

At least three (3) years from delivery of this product, Panasonic Corporation will give to any third party who contacts us at the contact information provided below, for a charge of no more than the cost of physically distributing source code, a complete machine-readable copy of the corresponding source code and the copyright notices covered under the GPL and the LGPL. Please note that software licensed under the GPL and the LGPL is not under warranty.

<http://panasonic.net/pcc/support/intercom/svn511/>

## 2. Important information

---

### 2.1 For your safety

To prevent severe injury and loss of life/property, read this section carefully before using the product to ensure proper and safe operation of your product.



#### Preventing fire and electric shock

- Use only the power source marked on the product. If you are not sure of the type of power supplied to your home, consult your dealer or local power company.
- Use only the specified power supply unit and AC cable.
- Do not attempt to disassemble or modify this product. Contact an authorised service centre for repairs.
- Never touch the power supply unit and AC cable with wet hands.
- Do not touch the power supply unit and AC cable during an electrical storm.
- Do not use the product (excluding the doorphone) in areas that are exposed to rain, moisture, steam, or oily smoke, or areas that have excessive dust.
- Do not perform any actions (such as fabricating, twisting, stretching, bundling, forcibly bending, damaging, altering, exposing to heat sources, or placing heavy objects on the power cable) that may damage the power cable. Using the product with a damaged power cable may cause electric shock, short circuits, or fire. Contact an authorised service centre for repairs.
- Do not overload the power outlet or wiring above the specified levels. Overloading by having many connections on one power outlet may cause heat generation, resulting in a fire.
- Never put metal objects inside the product. Never spill any liquid on the product (excluding the doorphone).  
If metal objects enter the product or the product becomes wet, turn off a circuit breaker or unplug the product from the power outlet and contact an authorised service centre.
- Completely insert the AC cable plug into the power outlets. Failure to do so may cause electric shock and/or excessive heat resulting in a fire. Do not use damaged AC cable plug or power outlets.
- Regularly remove any dust, etc., from the AC cable plug by unplugging them from the power outlets, then wiping them with a dry cloth. Accumulated dust may cause an insulation defect from moisture, etc., resulting in a fire.
- Turn off a circuit breaker or unplug the product from the power outlet if the product emits smoke, an abnormal smell or makes unusual noise, or if the product has been dropped or physically damaged. These conditions can cause fire or electric shock. Confirm that smoke has stopped emitting and contact an authorised service centre.

- When disconnecting the product from the power outlet, hold the AC cable plug and pull it out of the power outlet. Do not pull on the AC cable itself, as this may damage the cable and cause fire, electric shock, or injury.

#### Preventing accidents

- Do not use the product in health care facilities if any regulations posted in the area instruct you not to do so. Hospitals or health care facilities may be using equipment that could be sensitive to external RF (radio frequency) energy.
- Do not install or use this product near automatically controlled devices such as automatic doors and fire alarms. Radio waves emitted from this product may cause such devices to malfunction, resulting in an accident.
- Consult the manufacturer of any personal medical devices, such as pacemakers or hearing aids, to determine if they are adequately shielded from external RF (radio frequency) energy. (The product operates in the frequency range of 2.412 GHz and 2.472 GHz with a peak transmission power of 100 mW (max.).)



#### Preventing accidents, injuries, and property damage

- Do not use the product in unstable areas or areas prone to strong vibrations. This may cause the product to fall, resulting in damage to the product or injury.

---

### 2.2 Important safety instructions

When using this product, basic safety precautions should always be followed to reduce the risk of fire, electric shock, or personal injury.

1. Do not use this product near water. For example, near a bathtub, wash bowl, kitchen sink, or laundry tub, in a wet basement, or near a swimming pool, etc.
2. Use only the power supply unit and AC cable indicated in this manual.

#### SAVE THESE INSTRUCTIONS

---

### 2.3 Security cautions

- This product can use a wireless network to exchange various information between devices (e.g. personal computers, mobile devices, etc.). Because wireless signals can extend beyond the area in which you are using the product, even passing through obstacles such as walls, the following precautions are required when using the product connected to a wireless network.

**If you use this product connected to the Internet, please take appropriate security measures (such as encryption) according to the instructions provided with the wireless router.** Depending on the specifications of the wireless router, its security settings may be vulnerable to malicious attacks.

**If you do not take appropriate security settings, you might suffer from the following damages caused by a malicious third party:**

- Interception of communication contents (such as images, email information, IDs, passwords, etc.)
- Information theft
- Falsification of communication contents
- Configure the wireless router that connects your mobile device to this product to use encryption for all wireless communication.
- When submitting the product for repair, make a note of any important information stored in the product, as this information may be erased or changed as part of the repair process.
- Communications may be interrupted depending on network conditions and wireless signal quality.
- Panasonic will not be held responsible in the event of property loss caused by the lack of appropriate security measures or security issues related to wireless networks.

---

## 2.4 For best performance

### Location/avoiding noise

The main monitor uses radio waves to communicate.

- Confirm all the mobile devices are in range of the wireless router when you use the product use with wireless network.
- Install the main monitor away from electronic appliances such as TVs, radios, personal computers, wireless devices, or digital cordless phones.
- Install the main monitor facing away from radio frequency transmitters, such as external antennas of mobile phone stations. (Avoid installing the main monitor near a window.)
- Coverage and voice quality depends on the local environmental conditions.

### Environment

- Keep the unit (main monitor) away from electrical noise generating devices, such as fluorescent lamps and motors.
- The unit should not be exposed to direct sunlight.
- The unit should be kept away from heat sources such as radiators, cookers, etc. It should not be placed in rooms where the temperature is less than 0 °C or greater than 40 °C. Damp basements should also be avoided.
- Do not install the product in locations that are suspect to sudden changes in temperature. Failure to do so may cause condensation to form on the product causing malfunction.

- Obstructions can cause weak signals, noise, interrupted transmissions, distorted images and slow image refresh rates. Obstructions can include:
  - Metal doors or metal shutters.
  - Heat insulation including aluminium foil.
  - Concrete walls or walls made of galvanized iron sheet.
  - If the mobile device or wireless router is being used in a different building, or a different part of the house, i.e. a different floor to the where the main monitor has been installed.
  - Many walls.
  - Double insulated glass windows.
- Some types of hearing aids may receive noise from wireless communications between the main monitor and other compatible Panasonic units.
- Operating the unit near electrical appliances may cause interference. Move away from the electrical appliances.
- In areas surrounded by a high electrical field, disturbances may occur in the unit's image or sound.

---

## 2.5 Other important information

- AC cable plug is used as the main disconnect device. Ensure that the power outlet is installed near the product and is easily accessible.

---

### Privacy and rights of portrait

When installing or using the doorphone, please take into consideration the rights of others with regard to privacy.

- It is generally said that "privacy" means the ability of an individual or group to stop information about themselves from becoming known to people other than those whom they choose to give the information. "Rights of portrait" means the right to be safe from having your own image taken and used indiscriminately without consent.

---

### Personal information

The main monitor's internal memory records personal information (image and audio recordings of visitors, etc.). Panasonic assumes no liability for any unforeseen damages arising from the exposure of the recorded information.

- **Disclaimer**  
Recorded data may be altered or deleted as a result of incorrect operations, exposure to static electricity, accidents, malfunction, repairs or other operations. Panasonic assumes no liability for any direct or indirect damages resulting from the loss or alteration of recorded images.

### Requesting repairs for the product

- Before submitting the main monitor for repair, initialize it. This will delete all information saved in the main monitor.\*1
- Even if the product is sent for repairs without being initialized, the memory (including recorded data and

## 2. Important information

---

settings) for the main monitor may be cleared and set to factory default after repair.

- If operations cannot be performed due to the main monitor malfunction, consult with the place of purchase for appropriate action.

### Note for product disposal, transfer, or return

- This product can store your private/confidential information.  
To protect your privacy/confidentiality, we recommend that you erase the information (recorded images) from the memory before you dispose of, transfer or return the product.  
All the recorded images can be erased at once by initializing the main monitor.\*<sup>1</sup>

\*<sup>1</sup> Main monitor: perform “Factory Setting” in “Initialize settings”. (page 20)

---

### Disposal of Old Equipment (Only for European Union and countries with recycling systems)



This symbol (①) on the products, packaging, and/or accompanying documents means that used electrical and electronic products must not be mixed with general household waste.

For proper treatment, recovery and recycling of old products, please take them to applicable collection points in accordance with your national legislation. By disposing of them correctly, you will help to save valuable resources and prevent any potential negative effects on human health and the environment. For more information about collection and recycling, please contact your local municipality.

Penalties may be applicable for incorrect disposal of this waste, in accordance with national legislation.

### Information on Disposal in other Countries outside the European Union

Above symbol (①) is only valid in the European Union. If you wish to discard this product, please contact your local authorities or dealer and ask for the correct method of disposal.

---

### Others

- It is prohibited to disassemble or modify this product. Contact the dealer where you purchased this product for repair.
- When power fails, this product cannot be used.
- For the recorded image:  
The recorded image may be lost when:
  - Mishandled
  - Electric shock or radio wave interference occurs.
  - The power is turned off during use.

- Panasonic may not be liable for damages due to external factors such as power failures.
- If you stop using the main monitor and the doorphone, remove the main monitor and the doorphone from the walls to prevent them from falling off. (Consult your dealer for information about removing the product.)



## 3.1 Controls

### 3.1.1 Doorphone

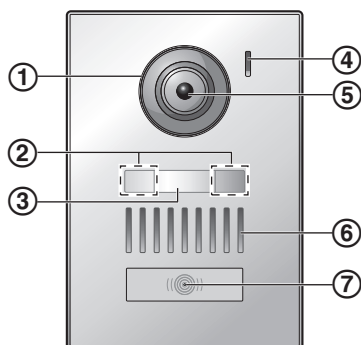

**① Lens cover**

**② LED lights**

Used to illuminate the visitor's face or the area in front of the doorphone so that the visitor's face can be seen in the dark.

**③ Name plate (supplied accessory)**

Can be attached as required when installing the doorphone.

**④ Microphone**

**⑤ Camera lens**

**⑥ Speaker**

**⑦ Call button and indicator (red)**

Lights in red when the power is on.

#### Doorphone image quality

The quality of doorphone images may change depending on the installation environment, settings, lighting conditions, the time of day, etc.  
See page 26 for more information.

### 3.1.2 Main monitor

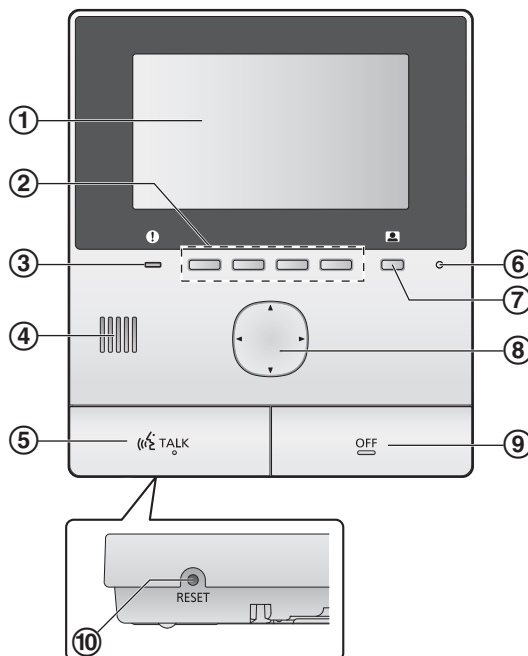

**① Display (page 10)**

**② Soft keys**

Allow you to select items displayed directly above each soft key.

Indicated in this document by the icon displayed above each soft key (page 10).

**③ Notification indicator (blue)**

Flashes when there is a notification (page 10).

When the top menu is displayed, the indicator stops flashing.

**④ Speaker**

**⑤ TALK button ([TALK])**

**⑥ Microphone**

**⑦ Monitor button ([MONITOR])**

**⑧ Navigator key**

Used to select items shown on the display, adjust settings, etc.

**⑨ OFF button ([OFF])**

**⑩ RESET button**

If the main monitor cannot be correctly operated, press the **[RESET]** button with a pointed object to reset the main monitor. (Recorded images and configured settings are not affected.)

## 3.2 Using the display

### Top menu

The top menu is the screen displayed when you press soft keys, navigator key, or off button. (It is only displayed if the date and time settings have been configured. See page 11.)

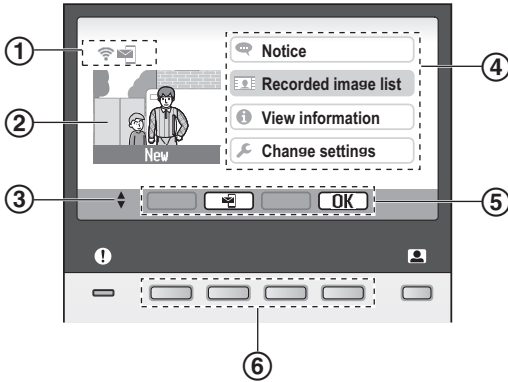

① Status icons (page 10)

② Recorded image

“New” is displayed when there are new (i.e., unplayed) images recorded.

③ Indicates the arrows of the navigator key that are available on the current screen.

④ Top menu items

⑤ Soft key icons

Indicate the item that will be selected when you press the soft key directly under each icon. The icons that are displayed vary depending on current screen and operation.

⑥ Soft keys

Select the items displayed directly above each soft key.

### Image viewing screen



① Status icons (page 10)

② Soft key icons (explained above)

### Top menu items

☰ Notice

Displays notifications.

This item is only available when there are new notifications available.

📷 Recorded image list

Displays the recorded image list (page 13).

- When there are new images recorded, the notification indicator flashes.

ℹ View information

Displays the record of sensor detections and Wi-Fi information.

🔧 Change settings

Displays the settings menu (page 18).

### Status icons



Indicates the signal strength of the wireless network.



Indicates that the main monitor is not connected to the wireless network.



Indicates the email notification feature is enabled.



Indicates the email notification feature is disabled.



Indicates which doorphone is calling, monitoring, or on a call. (“1” indicates the device number.)



Indicates there is a call from the doorphone when calling, monitoring, or on a call with another device.



Indicates that the main monitor is on a call.



Indicates that a doorphone and a PBX extension are talking.



Indicates that the main monitor is monitoring.



Indicates that images are being recorded (page 13).



Indicates that the doorphone’s LED lights are on (page 17).



Indicates that “Press-to-talk” mode is on (page 12).

\*1 AZ models only

### 3.3 Setting the language, date and time

When you use the main monitor for the first time, you will be prompted to set the display language, date, and time settings.

- The notification indicator flashes if these settings are not configured.
  - The language setting is available for EX and FX models only.
- 1 Press the [OFF] button to turn on the display.
  - 2 Use the navigator key (⤴) to select the desired language.
  - 3 Press the soft key under the  soft key icon.
  - 4 Press  again.
  - 5 Set the date and time.
    - Press the left or right side of the navigator key (⤴) to select an item (i.e., year, month, day, etc.).
    - Press the top or bottom side of the navigator key (⤴) to change the setting.
  - 6 When finished, press .
    - A beep sounds and the display turns off.

#### Changing the language, date and time

You change the language, date, and time settings later if desired. From the top menu, use the navigator key and  to navigate to "Change settings" → "Initial settings".

#### Note:

- The date and time settings may be deleted when there is a power outage. In this case, reconfigure the settings.
- The time may become out of sync over time (about 60 seconds per month).

### 3.4 Wide/zoom settings and zoom position settings

You can configure how doorphone images are initially displayed on the main monitor. Images can be displayed in wide mode or in zoom mode. You can choose different settings for when visitors call you, and for when you are monitoring.

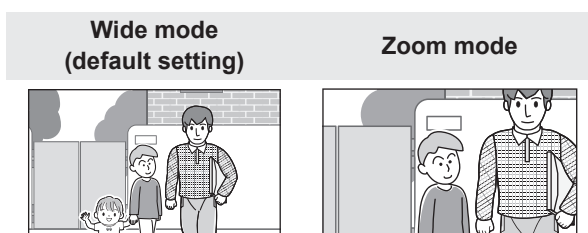

Wide mode (default setting)	Zoom mode
Images are not zoomed. The full camera image is displayed.	Images are zoomed. Images are displayed 2 times larger than wide display.

#### Note:

- The zoom feature uses a digital zoom. As a result, the image quality of zoomed images is lower than wide display images.
- You can switch between wide and zoom modes and adjust the zoom position while monitoring or on a call. See page 17.

#### Selecting wide or zoom

1. Top menu → select  → .
2. Select "Initial settings" → .
3. Select "Wide/zoom settings" → .
  - If there are multiple doorphones, select the doorphone to be configured → .
4. Select the desired setting → .
  - "When visitors come": Your settings will be used when you answer calls from visitors.
  - "When monitoring": Your settings will be used when you are monitoring.
5. Select the desired display mode → .
  - A beep sounds and the settings are changed.
6. Press [OFF].

#### Note:

- If you select "zoom", adjust the zoom position so that people or objects that you want to view are displayed centrally in the screen.
- When images are recorded in zoom mode, only the zoomed area is recorded.

#### Selecting the zoom position (pan/tilt position)

You can select which area of the image is displayed when displaying zoomed images.

1. Top menu → select  → .
2. Select "Initial settings" → .
3. Select "Zoom position settings" → .
  - If there are multiple doorphones, select the doorphone to be configured → .
  - A zoomed image from the doorphone is displayed.
4. Select the desired zoom position → .
  - A beep sounds, the settings are changed, and the display turns off.

#### Note:

- If you do not perform any operations for 90 seconds while changing this setting, the setting is cancelled and the screen turns off.

## 4. Talking and monitoring

---

### 4.1 Answering doorphone calls

When you receive a call from a doorphone, the main monitor rings, and displays an image from the doorphone.

#### To answer the call

Press **[TALK]**.

- Speak within about 50 cm of the microphone.
- Speak alternatively with the visitor. If you and the visitor speak at the same time, you will not hear each other.
- You can talk for up to about 90 seconds.

#### To end the call

Press **[OFF]**.

#### Note:

- The display will turn off if you do not answer a call within about 30 seconds.
- The displayed images are automatically recorded to the main monitor (page 13).

---

#### Features available during incoming calls

- Monitoring feature (page 12)

---

#### Features available while talking

- Adjusting wide/zoom and pan/tilt settings (page 17)
- Turn on or off the operation guide (page 17)
- Adjusting sound and display settings (page 17)
- Using "press-to-talk" (page 12)

---

#### Press-to-talk mode

If it is difficult for you and the visitor to hear each other due to noise, the "press-to-talk" mode can make conversations easier to hear.

1. While talking, activate press-to-talk mode by pressing and holding **[TALK]** for about 2 seconds.
  - A beep sounds and  is displayed.

2. **To speak to the visitor**

Speak while pressing and holding **[TALK]**.

- To listen to the visitor**

Release **[TALK]**.

#### Note:

- Press-to-talk mode is cancelled when the call ends.

### 4.2 Monitoring the outside with the doorphone

You can monitor the sounds and images from the doorphone.

- 1 Press .

- If there are multiple doorphones, select the desired doorphone → **[OK]**.
- The images from the doorphone are displayed.

- 2 Monitor the sound and image.

- You can talk to the monitored party by pressing **[TALK]**.

- 3 Press **[OFF]**.

#### Note:

- The sound from your end will not be heard at the doorphone.
- You can monitor for up to about 3 minutes.

---

#### Features available while monitoring

- Recording doorphone images (page 13)
- Adjusting wide/zoom and pan/tilt settings (page 17)
- Turn on or off the operation guide (page 17)
- Adjusting sound and display settings (page 17)

## 5.1 Recording doorphone images

The main monitor can record doorphone images (still images). It can save images from up to 50 doorphone calls or monitoring sessions. Each time new images are recorded, they are saved in an image set of up to 8 images.

### 5.1.1 Recording automatically (recording a received call)

When a visitor calls you, the main monitor records 8 images automatically (whether you answer the call or not). Recording starts about 2 seconds after you receive the call.

#### When you do not answer a call

The recorded images are saved as unplayed images, and the notification indicator flashes.

#### When there are multiple doorphones

- When you are talking or monitoring and there is an incoming call from another doorphone, images from the incoming call will not be displayed and recorded. In order to display and record incoming calls, you must end the current call or stop monitoring.
- If there is an incoming call from another doorphone, while receiving an incoming call, the number of recorded images from the 1st caller (8 images) are reduced.

#### When the memory is full (auto image updating)

When the memory is full, new images overwrite the oldest images automatically. This occurs even if the oldest images are unplayed images.

### 5.1.2 Recording manually (recording while monitoring)





While monitoring, press . Up to 8 images will be recorded.

-  is displayed on the screen when recording.

## 5.2 Playing recorded images

When there are new (i.e., unplayed) images recorded, the notification indicator (page 9) flashes and “New” is displayed in the top menu (page 10).

- 1 Top menu →  → .
  - “Recorded image list” screen is displayed.
- 2 Select “Unplayed images” (for new images) or “Played images” (for images that have been played) → .
  - The most recent image set of the selected type is displayed.
- 3 Browse the image sets and images.
  - The following operations are available.

-  Browses image sets, from newer ones to older ones
-  Browses image sets, from older ones to newer ones
-  Browse images within an image set
-  Plays back all images in an image set continuously
-  Pauses continuous playback

- 4 Press [OFF].

#### Note:

- The notification indicator stops flashing when the top menu is displayed.
- “New” in the top menu disappears from the display when “Unplayed images” in “Recorded image list” is displayed.



### 5.2.1 Image playing screen

#### Image playing screen







- 1 Device number
- 2 Image set number
- 3 Image position within a image set
- 4 Recording date and time

#### Status icons

-  Indicates that the image has not been played.
-  Indicates the number of the doorphone that recorded the image.
-  Indicates that the image is protected (i.e., cannot be deleted)

#### Available soft keys

-  Plays back all images in an image set continuously
-  Pauses continuous playback
-  Returns to the previous screen
-  Displays the options menu

### 5.2.2 Options available when playing images



While playing images, you can press  to display the options menu and change the following settings.

#### To turn off the operation guide



 → .

- While the guide is turned off, the soft keys do not operate their respective features. Press any soft key to display the guide again briefly. During this time, the soft keys can be operated as normal.

#### To turn on the operation guide

Press any soft key to display the guide →  → .

#### To turn protection on and off

 → select “**Protect**” (to turn protection on) or “**Remove protection**” (to turn protection off) → .

- When “**Protect**” is selected, the image cannot be deleted.
- A maximum of 20 image sets can be protected.

#### To delete the current image

 → select “**Delete**” →  → .

- You can use “**Delete all images**” to delete all images in one operation. See page 20.

#### To adjust the screen brightness

 → select “**Brightness**” → adjust the brightness.

## 6.1 Using electric locks

When a commercially available electric lock is connected to the main monitor, you can unlock a door or gate using the main monitor. You can also select the length of time control signals are sent for to unlock the door or gate. (How long the door or gate remains unlocked depends on each electric lock's specification.)

- A maximum of 2 electric locks can be connected to the main monitor. When you use an additional doorphone, the maximum number of the electric locks that can be connected to the doorphone depends on the type of doorphone. Consult your dealer for further information.
- For detailed information about connections, see the operating instructions included with the electric lock and the Installation Guide of this product.

### 6.1.1 Configuring electric locks

- 1 Top menu →  → .
- 2 Select "Connected devices" → .
- 3 Select "Electric lock" → .
- 4 Select the doorphone ("Doorphone 1" or "Doorphone 2") that you want to assign the electric lock to → .
- 5 Select the type of the electric lock → .
- 6 Select the device that the electric lock is connected to → .
- 7 Select the unlocking time → .
- 8 Press [OFF].

#### Electric lock settings

Options listed below are available.

"Unlocking buzzer sound":

Determines whether the doorphone sounds a buzzer when the electric lock is unlocked. See page 19.

"View extension after unlocking":

Determines whether to extend the displaying time of the doorphone image when the electric lock is unlocked. See page 19.

### 6.1.2 Unlocking electric locks

- 1 Press  while talking or monitoring.
  - If there are 2 electric locks available, select the electric lock to be unlocked →  → press  to unlock another electric lock.

#### Note:

- You can only unlock the door or gate when talking or monitoring.
- When using multiple electric locks with different doorphones, you can only operate the locks from the doorphone that they are connected to.

## 6.2 Using sensors

When commercially available sensors (such as a fire alarm, calling button, etc.) are connected to the main monitor, you can receive notifications on the main monitor if the sensors are triggered.

- A maximum of 2 sensors can be connected to the main monitor.
- For detailed information about connections, see the operating instructions included with the sensor and the Installation Guide of this product.

### 6.2.1 Stopping an alarm

When a connected sensor is triggered, the main monitor sounds an alarm and displays a message indicating which sensor was triggered.

The alarm sounds for 3 minutes.

- 1 To stop an alert, press [OFF].
  - The alarm cannot be stopped during the first 5 seconds.

#### Note:

- When installing or performing maintenance on connected sensors, check that the main monitor can correctly receive alarms from the sensors.
- If a sensor is triggered when you are monitoring or on call, the main monitor ends the monitoring or the call.
- The main monitor cannot receive doorphone calls while the alarm is sounding.

## 6.3 Panasonic PBX integration



This feature is available for AZ models only.

Connecting the main monitor to a PBX allows you to use PBX extensions to answer doorphone calls.

**Please use only a Panasonic PBX (page 4).**

- For detailed information about connections, see the operating instructions included with the PBX and the Installation Guide of this product.

#### Note:

- If you answer a doorphone call with a PBX extension, the doorphone camera image will be displayed on the main monitor, and  is displayed to indicate that a PBX extension is on the call.
- While  is displayed, you cannot answer calls using the main monitor.
- The display will turn off when the call between the doorphone and the PBX extension ends, or after 3 minutes.
- If you answer a doorphone call with the main monitor, the call will continue to ring at the extension for about 15 to 30 seconds. After you answer the call, the extension user cannot answer the call or join the call, even if the extension is ringing.

## ***6. Using electric locks and other devices***

---

### **When using two doorphones (excluding an optional lobby station; page 3)**

From the PBX extension, you can only call the doorphone that you last received call from or talked with.



## 7.1 Zooming in and out (wide/ zoom, pan/tilt)

When on a call or monitoring, you can display images in wide mode or in zoom mode. During zoom mode, you can change the zoom position (also called "pan/tilt").

### To switch from wide mode to zoom mode

Press .

### To switch from zoom mode to wide mode

Press .

### To change the zoom position

Use the navigator key.



#### Note:

- See page 11 for examples of wide mode and zoom mode.
- The zoom feature uses a digital zoom. As a result, the image quality of zoomed images is lower than wide display images.
- When images are recorded in zoom mode, only the zoomed area is recorded.
- If you adjust these settings, the settings will be cancelled the next time you display an image. To change how doorphone images are initially displayed on the main monitor, see page 11.

## 7.2 Sound and display settings for calls and monitoring

While monitoring or on a call, you can press  to display the options menu and change sound and display settings.



### To adjust the incoming call volume\*1

 → "Sound" →  → "Receiver volume" → adjust the volume.

### To adjust the volume heard at the doorphone\*1

 → "Sound" →  → "Owner's voice volume" → select the desired setting.

### To use the voice changer\*1

 → "Sound" →  → "Voice changer" → select the desired setting.



- When "On" is selected, the voice heard at the doorphone sounds deeper.

### To turn off the operation guide



 → .

- While the guide is turned off, the soft keys do not operate their respective features. Press any soft key to display the guide again briefly. During this time, the soft keys can be operated as normal.



### To turn on the operation guide

Press any soft key to display the guide →  → .



### To adjust the screen brightness

 → "Display" →  → "Brightness" → select the desired setting.

### To adjust backlight compensation

 → "Display" →  → "Backlight compensation" → select the desired setting.

### To turn the LED lights on or off

 → "Display" →  → "Illumination" → select the desired setting.

-  is displayed when the LED lights are on.

\*1 These settings cannot be changed during an incoming call.

## 7.3 Ringtone settings

### 7.3.1 Ringtone type and volume settings

You can change the ringtone type and volume that is heard during an incoming call.

- For information about how to configure settings, see page 18.

## 7. Additional functions

### 7.4 Function settings list

You can change the settings to match how the main monitor is used.

- 1 Top menu →  → .
- 2 Select the desired item → .
  - Repeat this step as necessary to navigate to the desired setting.
- 3 Select the desired setting → .
- 4 Press [OFF].

**Note:**

- If you do not perform any operations for 90 seconds while changing these settings, or if an incoming call is received, the setting is cancelled and the screen turns off.
- In the following table, default settings are indicated by < >.
- While changing settings, “●” is displayed to the left of the currently selected item.

**Item name: “Initial settings”**

Sub-menu			Settings	
1	2	3		
Time and date settings <sup>*1</sup>	–	–	2015-1-1 0:00	
Zoom position settings	Doorphone 1 - 2	–	–	For details, see page 11.
Wide/Zoom settings	Doorphone 1 - 2	When visitors come/When monitoring	Zoom, <Wide>	
Power supply frequency	–	–	<50 Hz>, 60 Hz – To prevent mottled or uneven colour from being displayed, choose the appropriate power supply frequency for your area.	
Select language <sup>*1, *2</sup>	–	–	<b>EX models</b> <English>, Français, Deutsch, Italiano, Español, Nederlands <b>FX models</b> <English>, Polski, Română, Magyar	

\*1 When using the product for the first time, follow the on-screen instructions to configure this setting (page 11).

\*2 EX and FX models only

**Item name: “Ringtone”**

Sub-menu		Settings	
1	2		
Ring volume	–	<Loud>, Normal, Quiet, Mute	
Ringtone	Doorphone 1	<Sound 1>, Sound 2, Sound 3	<Normal>, Repeat
	Doorphone 2	Sound 1, <Sound 2>, Sound 3	<Normal>, Repeat

## Item name: "Connected devices"

Sub-menu				Settings	
1	2	3	4		
Doorphone connection <sup>*1</sup>	Doorphone 1	–	–	<Device connected>, Auto detection, Device not connected	
	Doorphone 2	–	–	Device connected, <Auto detection>, Device not connected	
Electric lock	Doorphone 1 - 2	Electric door lock/ Electric vehicle gate lock	Connect to relay box (1)/Connect to relay box (2)/Connect to the doorphone/ <No connection>	<Unlock for 1 second> -Unlock for 7 seconds	
	Unlocking buzzer sound	–	–	<On>, Off	For details, see page 15.
	View extension after unlocking	–	–	Enable, <Disable >	
Automatic illumination <sup>*3</sup>	Doorphone 1 - 2	When visitors come/When monitoring	–	<Enable>, Disable	
Lobby connection <sup>*2</sup>	–	–	–	Device connected, <Device not connected>	

\*1 Select "Device not connected" for doorphones that are no longer used.

\*2 AZ models only

\*3 With this setting, you can select whether or not to automatically turn on the LED lights when the area surrounding the doorphone is dark.

## Item name: "Network"

Sub-menu		Settings
1	2	
Current status <sup>*1</sup>	Wi-Fi information	–
	IP configuration information	–
	Email setting confirmation	–
Wi-Fi	Easy setting (WPS) <sup>*2</sup>	–
	Manual setting	Search and select/SSID and security key input
IP settings <sup>*3</sup>	–	Automatic (DHCP)/Manual (Static)

## 7. Additional functions

Sub-menu		Settings
1	2	
Email settings	Email notification	On, <Off>
	Email server registration <sup>*4</sup>	–
	Email server deregistration <sup>*5</sup>	–
	Email notification address <sup>*6</sup>	–
Notification selection	Doorphone 1 - 2, Sensor 1 - 2	<On>, Off
Initialization of network <sup>*7</sup>	–	–

\*1 Displays the status of the wireless network connection

\*2 Easy Wi-Fi configuration

\*3 If you want to use your specified IP address for the main monitor, select “**Manual (Static)**” and set the information as required.

\*4 Sets the email server information (page 23).

\*5 Deletes the email server information

\*6 Sets the email address that you want to send the notification to (page 24).

\*7 “**Wi-Fi information**”, “**IP settings**”, and “**Email settings**” will be initialized.

### Item name: “Register/Cancel”

Sub-menu		Settings
1	2	
Register	Smartphone 1 - 4	–
Cancel	–	–

### Item name: “Other”

Sub-menu	Settings
1	
Flash notification indicator	<Enable>, Disable
Delete all images	Delete all images/Delete Non-protected images
Initialize settings	Default Setting <sup>*1</sup> /Factory Setting – Select “ <b>Factory Setting</b> ” when disposing, transferring, or returning the product.
Demo mode	On, <Off> Do not use this setting unless the product is being used in a sales display.

\*1 The following settings are not initialized.

- “**Power supply frequency**”, “**Select language**”, and “**Electric lock**” settings.
- Registration information of devices registered to the main monitor. (All devices remain registered to the main monitor even after initialization.)

## 8.1 Network connections

The main monitor can connect to various devices over Wi-Fi and over the Internet, allowing you to receive notifications even when away from home. You can also use the dedicated **[Video Intercom]** app and access main monitor features using your mobile devices, such as smartphones and tablets.

The following illustrates how the main monitor can connect to your devices over Wi-Fi and over the Internet.

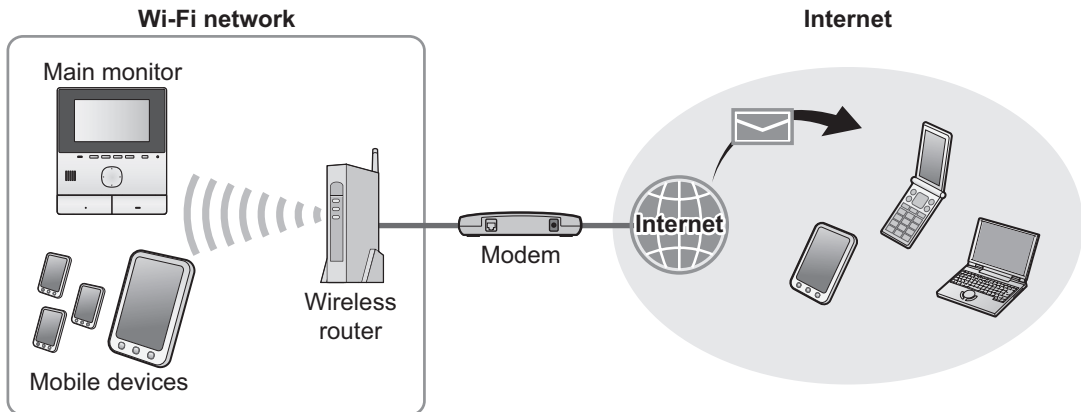

### Note:

- The main monitor must be connected to a Wi-Fi network in order to connect to other devices and to the Internet (page 21).
- In order to use the **[Video Intercom]** app with your mobile devices, you must register them to the main monitor (page 23). You can register up to 4 mobile devices.
- An Internet connection is required to use these features.

## 8.2 Entering text

When configuring network settings, you can use the navigator key and the on-screen keyboard to enter text.

### Text input screen (example)

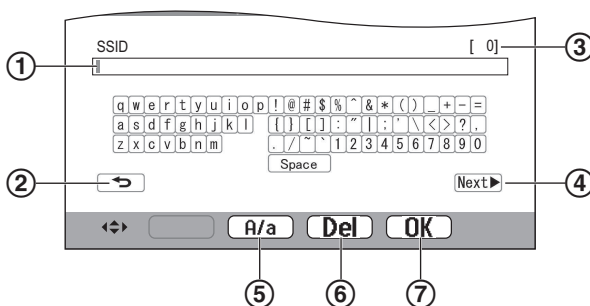

- ① Text entry area
- ② Returns to the previous screen
- ③ Number of entered characters
- ④ Switches to the next screen
- ⑤ Switches between uppercase and lowercase text entry
- ⑥ Deletes characters
- ⑦ Confirms the selected input or action

- The text input screen varies depending on the item that you are configuring.

### Entering text

1. Select the desired character → .
- Repeat this step for required characters.
2. Select  → .

### Editing text

1. Select the text entry area.
2. Select the desired cursor position.
3. Change the text as desired.

## 8.3 Connecting to a Wi-Fi network

The main monitor connects to the Internet using your Wi-Fi network. You can configure Wi-Fi settings using a simplified method (called WPS), or manually.

### Simplified configuration (Easy setting (WPS))

This procedure requires a wireless router that supports WPS. If your wireless router supports WPS, make sure the feature is turned on, and locate its WPS button before beginning this procedure. The WPS button is typically labelled "WPS" or has two curved arrows on it.

1. Top menu → → .
2. Select "Network" → .

## 8. Wi-Fi, mobile devices, and email



3. Select “Wi-Fi” → .
4. Select “Easy setting (WPS)” → .
5. Press the WPS button on your wireless router within 2 minutes.
6. Press  on the main monitor.

### Note:

- Operations may vary depending on your wireless router. Refer to the operating instructions included with the wireless router for more information.

### Manual configuration

If your wireless router does not support WPS, you can manually configure the main monitor's Wi-Fi settings. You can either search for available Wi-Fi networks or enter the SSID (wireless network name) manually.

1. Top menu →  → .
2. Select “Network” → .
3. Select “Wi-Fi” → .
4. Select “Manual setting” → .
5. To search for available Wi-Fi networks
  - a. Select “Search and select” → .
  - The main monitor displays available Wi-Fi networks.
    -  indicates the signal strength of the wireless network.
    -  indicates that the wireless network is secured.
  - b. Select the desired Wi-Fi network → .
  - c. Confirm the SSID → .
  - d. If required, enter the security key for the Wi-Fi network → select  → .

### To enter the SSID directly

- a. Select “SSID and security key input” → .
- b. Enter the SSID → select  → .
- c. Select the security type → .
- d. If required, enter the security key for the Wi-Fi network → select  → .

### Note:

- See page 21 for information on how to enter text.
- Operations may vary depending on your wireless router. Refer to the operating instructions included with the wireless router for more information.

## 8.4 Using mobile devices

The [Video Intercom] app allows you to use your mobile device as an extension of the main monitor.

### Main features

- Answer doorphone calls
- Monitor doorphone images
- Configure email notification settings

### Compatible mobile devices

- iPhone 5 or later, iPad (iOS 7.0 or later)
- Android smartphones and tablets (Android 4.0 or later)

### Note:

- In order to use the [Video Intercom] app with your mobile devices, you must register them to the main monitor. You can register up to 4 mobile devices.
- Mobile devices can connect to the main monitor only if they are connected to the same Wi-Fi network as the main monitor.
- For the latest information about the [Video Intercom] app and compatible devices, visit the following website.



<http://panasonic.net/pcc/support/intercom/smartphone/>

### 8.4.1 Mobile device preparation overview

- 1 Connect the main monitor to your Wi-Fi network (page 21).
- 2 Enable the mobile device's Wi-Fi feature and connect the mobile device to the same Wi-Fi network as the main monitor.
  - Refer to the operating instructions included with your mobile device for information about connecting to Wi-Fi networks.
- 3 Download and install the [Video Intercom] app.
  - Visit the following website for more information.  
<http://panasonic.net/pcc/support/intercom/smartphone/>
- 4 Register your mobile device to the main monitor (Page 23).

### 8.4.2 Registering your mobile device to the main monitor

For more information about registering mobile devices, refer to the operating instructions for the **[Video Intercom]** app.

#### Mobile device operations

1. Start the **[Video Intercom]** app.
2. Read the displayed license agreement and tap **[Agree]**.



#### Main monitor operations

1. Top menu →  → .
2. Select “**Register/Cancel**” → .
3. Select “**Register**” → .
4. Select the mobile device registration number → .



#### Mobile device operations

Complete these operations within 2 minutes.

1. Read the displayed message and tap **[Register]**.



#### Main monitor operations

1. Confirm that registration was completed from the displayed message → **[OFF]**.

### 8.4.3 Cancelling the mobile device from the main monitor

If you do not plan on using the **[Video Intercom]** app any longer, we recommend cancelling the mobile device from the main monitor.

1. Top menu →  → .
2. Select “**Register/Cancel**” → .
3. Select “**Cancel**” → .
4. Select the mobile device registration number → .
5. Press **[OFF]**.

## 8.5 Using email features

The main monitor can send a doorphone image via email when someone presses the call button, and send an email message when the sensor connected to the doorphone is triggered.

### 8.5.1 Email features preparation overview

1. Connect the main monitor to your Wi-Fi network (page 21).
2. Gather the following information.
  - The email address (your email address) that you want to use for sending email messages from the main monitor. Note that mobile phone-exclusive addresses cannot be used.
  - The email server name (typically starts with "SMTP") associated with the email address
  - The SMTP port number used to send email
  - The type of encryption used by the email server (such as TLS/SSL, or none)
  - The SMTP authentication user name and security key used by the email server (not required for all email servers)
3. Register the email server and notification email addresses (page 23).

#### Note:

- The main monitor must be connected to a Wi-Fi router that is connected to the Internet in order to use email feature.
- Messages sent from the main monitor may not be able to be received if they are treated as spam by the destination email account. Configure the email account so that email from the main monitor can be received.
- Email may not be able to be sent depending on the condition of the network.
- You can also configure email features using the **[Video Intercom]** app.

### 8.5.2 Registering the email server

1. Top menu →  → .
2. Select “**Network**” → .
3. Select “**Email settings**” → .
4. Select “**Email server registration**” → .
5. Enter the sender email address → select  → .
6. Enter the SMTP server address → select  → .
7. Enter the port number → select  → .
8. Select the security type → .

## 8. Wi-Fi, mobile devices, and email

9 Select whether to use SMTP authentication or not →  OK.

### 10 If you selected "Off"

Continue to the next step.

#### If you selected "On"

- a. Enter the account name → select  →  OK.
- b. Enter the password → select  →  OK.
  - See page 21 for entering text.

11 Confirm the message →  Yes.

- A test message is sent to the specified email address. Confirm that the message has arrived at the specified email address.

#### Note:

- See page 21 for information about entering text.

---

### 8.5.3 Registering the notification email addresses

You can register up to 4 email addresses that will be used to receive notifications from the main monitor.

- 1 Top menu →  →  OK.
- 2 Select "Network" →  OK.
- 3 Select "Email settings" →  OK.
- 4 Select "Email notification address" →  OK.
- 5 Select a memory location number →  OK.
- 6 Enter the email address → select  →  OK.
  - See page 21 for information about entering text.
- 7 Confirm the message →  Yes.
  - A test message is sent to the specified email address.
- 8 Confirm that the message has arrived at the specified email address →  OK.
  - The email address is registered and "Email notification" is automatically enabled.
  - To register more email accounts, repeat this procedure from step 4.

---

### 8.5.4 Enabling/disabling email notifications

"Email notification" is automatically enabled when the email server and email addresses are registered. If you do not want notifications to be sent, for example when you are home, follow the steps below to disable notifications.

- 1 Top menu →  →  OK.
- 2 Select "Network" →  OK.
- 3 Select "Email settings" →  OK.

4 Select "Email notification" →  OK.

5 Select "Off" →  OK.

- Select "On" to enable notifications.

#### Note:

- The status of the email notification feature is displayed in the top menu, see "Status icons" in page 10.
- You can change the setting with following procedure:  
Top menu →

---

### 8.5.5 Selecting devices to trigger email notifications

You can select which devices, doorphones, or sensors, will trigger email notifications.

- 1 Top menu →  →  OK.
- 2 Select "Network" →  OK.
- 3 Select "Notification selection" →  OK.
- 4 Select the desired device →  OK.
- 5 Select "On" →  OK.
  - Select "Off" to disable notifications for the selected device.



## 9.1 Cleaning

Wipe the product with a soft, dry cloth.

For excessive dirt, wipe the product with a moist cloth.

**Important:**

- Do not use any cleaning products that contain alcohol, polish powder, powder soap, benzine, thinner, wax, petroleum, or boiling water. Also do not spray the product with insecticide, glass cleaner, or hair spray. This may cause a change in colour or quality of the product.

## 9.2 Specifications

### Main monitor (VL-MVN511)

<b>Power source</b>	Power supply unit (VL-PS240/ VL-PS241) 24 V DC, 0.5 A
<b>Power consumption</b>	Standby: approx. 1.8 W During operation: approx. 10 W
<b>Dimensions (mm) (height × width × depth)</b>	Approx. 186×161×23.5 (excluding protruding sections)
<b>Mass (weight)</b>	Approx. 485 g
<b>Operating environment</b>	Ambient temperature: approx. 0 °C to +40 °C Relative humidity (non-condensing): up to 90 %
<b>Display</b>	Approx. 12.7 cm (5 inches wide colour display)
<b>Talking method</b>	Hands-free
<b>Installation method</b>	Wall mount (mounting bracket supplied)
<b>Wireless transmission method</b>	IEEE 802.11 b/g/n
<b>Encryption</b>	WPA/WPA2, WEP
<b>Frequency range</b>	2.412 GHz to 2.472 GHz
<b>RF transmission power</b>	100 mW (max.)

### Power supply unit (VL-PS240/VL-PS241) (indoor use only)

<b>Power source</b>	Input: 220-240 V AC, 0.2 A, 50/60 Hz Output: 24 V DC, 0.6 A
<b>Dimensions (mm) (height × width × depth)</b>	VL-PS240: Approx. 116×100 ×54 VL-PS241: Approx. 104×100 ×54 (excluding protruding sections)

<b>Mass (weight)</b>	VL-PS240: Approx. 230 g VL-PS241: Approx. 215 g
<b>Operating environment</b>	Ambient temperature: approx. 0 °C to +40 °C Relative humidity (non-condensing): up to 90 %
<b>Installation method</b>	VL-PS240: Attach to DIN rail

### Relay box (VL-RLY1)

<b>Power source</b>	Power supplied by the main monitor
<b>Dimensions (mm) (height × width × depth)</b>	Approx. 92×78×38 (excluding protruding sections)
<b>Mass (weight)</b>	Approx. 130 g
<b>Operating environment</b>	Ambient temperature: approx. 0 °C to +40 °C Relative humidity (non-condensing): up to 90 %
<b>Installation method</b>	Attach to DIN rail

### Doorphone (VL-V555)

<b>Power source</b>	Power supplied by the main monitor
<b>Dimensions (mm) (height × width × depth)</b>	Approx. 169×118×30 (excluding protruding sections)
<b>Mass (weight)</b>	Approx. 395 g
<b>Operating environment</b>	Ambient temperature: approx. -15 °C to +55 °C Relative humidity (non-condensing): up to 90 %
<b>Viewing angle</b>	Horizontally: approx. 170° Vertically: approx. 130°
<b>Installation method</b>	Wall mount (mounting base supplied)
<b>Minimum illuminance required</b>	1 lx (within approx. 50 cm from the camera lens)
<b>Lighting method</b>	LED lights
<b>IP rating</b>	IP54*1
<b>IK rating</b>	Compliant with IK07

\*1 Water resistance is only assured if the doorphone is installed correctly according to the instructions in the Installation Guide, and appropriate water protection measures are taken.

**Note:**

- Design and specifications are subject to change without notice.

### 10.1 Troubleshooting

#### Monitor display (doorphone images)

Problem	Cause & Solution	Page
Images appear distorted.	<ul style="list-style-type: none"> <li>Images may appear distorted because of the characteristics of the camera lens. This is not a malfunction.</li> </ul>	–
The background appears greenish.	<ul style="list-style-type: none"> <li>At night or when there is poor light in the area around the doorphone, lights or white objects near the doorphone may appear greenish. This is not a malfunction.</li> </ul>	–
Images at night are dark and faces cannot be identified.	<ul style="list-style-type: none"> <li>“<b>Automatic illumination</b>” is set to “<b>Disable</b>”. → Change the setting to “<b>Enable</b>”.</li> <li>Even when the doorphone’s LED lights are lit, because the light from the LED lights cannot illuminate the edges of the visible area (the areas directly next to the doorphone), faces of people may not be identifiable even when they are close to the doorphone. → We recommend installing extra lights in the area around the doorphone.</li> </ul>	19 –
The images of people’s faces are dark.	<ul style="list-style-type: none"> <li>Images of people’s faces appear dark when there is strong sunlight or a backlight in the area around the doorphone. → Use the backlight compensation function.</li> </ul>	17
Images are dirty or unclear. <ul style="list-style-type: none"> <li>Images are not in focus.</li> </ul>	<ul style="list-style-type: none"> <li>There is dirt on the surface of the doorphone’s lens. → Wipe the lens with a soft, dry cloth.</li> <li>There is water condensation on the surface of the doorphone’s lens. → Wait for the condensation to evaporate.</li> </ul>	25 –
Images are white or black.	<ul style="list-style-type: none"> <li>The brightness of the display is not correctly adjusted. → Adjust the brightness when images are displayed.</li> </ul>	14
Images are white, or white lines or circles are shown on the display.	<ul style="list-style-type: none"> <li>Strong light such as sunlight is shining into the lens of the doorphone causing images to be difficult to see on the display. (This is not a malfunction.) → Locating the doorphone away from direct sunlight or changing the angle that the doorphone is installed may help reduce this problem.</li> </ul>	–
Images are flickering.	<ul style="list-style-type: none"> <li>AC (alternating current) lights such as fluorescent lights are used near the doorphone. → AC (alternating current) lights such as fluorescent lights may cause flickering in dark environments. (This is not a malfunction.)</li> </ul>	–
Images of the area you want to view in the zoom screen are not displayed correctly.	<ul style="list-style-type: none"> <li>Change the zoom position setting to a suitable position. → Configure the “<b>zoom position settings</b>” settings.</li> </ul>	11

#### Ringtone

Problem	Cause & Solution	Page
The ringtone for the doorphone does not sound.	<ul style="list-style-type: none"> <li>The ringtone volume is muted. → Activate the sound for the ringtone.</li> </ul>	18

## Mobile device

Problem	Cause & Solution	Page
<p>Mobile devices cannot be registered.</p> <p>Mobile devices cannot connect to the system.</p>	<ul style="list-style-type: none"> <li>● The main monitor and/or your mobile device is not connected to your wireless router. <ul style="list-style-type: none"> <li>→ Both the main monitor and your mobile devices must be connected to your wireless router.</li> </ul> <p><b>Main monitor:</b> Complete the Wi-Fi settings.</p> <p><b>Your mobile device:</b> Turn on the Wi-Fi feature and connect to the wireless router that the main monitor is connected to. For more information, see the operating instructions of your wireless router and mobile devices.</p> </li> <li>● The main monitor and/or your mobile devices is out of range of your wireless router. <ul style="list-style-type: none"> <li>→ Confirm your wireless router is turned on and both the main monitor and your mobile device are in range of your wireless router. (The mobile device cannot connect to the system when it is out of the range of the wireless router that the main monitor is connected to, such as when you are away from home.)</li> </ul> </li> <li>● The main monitor and your mobile device are not connected to the same wireless router. <ul style="list-style-type: none"> <li>→ Confirm that the both main monitor and your mobile device are connected to the same wireless router.</li> </ul> </li> <li>● When the all above remedies do not solve the problem <ul style="list-style-type: none"> <li>→ Try “<b>Initialization of network</b>” and then set “<b>Wi-Fi</b>” again.</li> </ul> </li> </ul>	21, 23
<p>Video Intercom does not work properly even if wireless network and device registration are confirmed.</p>	<ul style="list-style-type: none"> <li>● Refer to the troubleshooting section of the operating instructions of the Video Intercom app.</li> </ul>	–

## Email feature

Problem	Cause & Solution	Page
<p>Test mail cannot be delivered.</p>	<ul style="list-style-type: none"> <li>● The email server and email address are not set correctly. <ul style="list-style-type: none"> <li>→ Confirm these settings in “<b>Email settings</b>” and reconfigure them as required.</li> </ul> </li> </ul>	23
<p>Email notification is not delivered even if the email settings are confirmed.</p>	<ul style="list-style-type: none"> <li>● The wireless router is off or the main monitor is out of ranager of the wireless router. <ul style="list-style-type: none"> <li>→ Confirm that the wireless router is turned on and that the main monitor is in range of the wireless router.</li> </ul> </li> <li>● “<b>Email notification</b>” setting is “<b>Off</b>”. <ul style="list-style-type: none"> <li>→ Set the “<b>Email notification</b>” settings to “<b>On</b>”.</li> </ul> </li> <li>● There is something wrong with the network settings, such as the “<b>Email server registration</b>” settings. <ul style="list-style-type: none"> <li>→ Check the inbox of the sender email that is set in “<b>Email server registration</b>” to see if there were any messages that could not be delivered.</li> </ul> </li> </ul>	23
<p>I want to stop email notification temporarily (e.g. when I am home).</p>	<ul style="list-style-type: none"> <li>● Set the “<b>Email notification</b>” settings to “<b>Off</b>”.</li> </ul>	24

## 10. Troubleshooting

### Others

Problem	Cause & Solution	Page
<ul style="list-style-type: none"><li>● “Demo mode” is displayed on the screen.</li><li>● The ringtone regularly sounds.</li><li>● You cannot talk or make calls.</li></ul>	<ul style="list-style-type: none"><li>● The “Demo mode” feature is enabled. → Set “Demo mode” to “Off”.</li></ul>	20
The product does not work with correct operations. The product does not work properly.	<ul style="list-style-type: none"><li>● Perform the following operations.<ul style="list-style-type: none"><li>– Press the <b>[RESET]</b> button on the bottom side of the main monitor with a pointed object. (Recorded images and configured settings are not affected.)</li></ul></li></ul>	9
The main monitor does not work properly. <ul style="list-style-type: none"><li>● Nothing is displayed on the monitor.</li><li>● The ringtone does not sound.</li><li>● Voices cannot be heard.</li></ul>	<ul style="list-style-type: none"><li>● Check the power connection.</li><li>● If the power is connected, there may be a problem with the electrical wiring. → Contact an authorised service centre.</li></ul>	–

## 10.2 Error messages

### When using devices for the first time or registering devices

Display	Cause & Solution	Page
IP address is duplicated.	<ul style="list-style-type: none"><li>● The same IP address of the main monitor is used by another device. → Confirm the current IP address of the main monitor (page 19), and then reconfigure it so that it does not overlap with other IP addresses (page 19).</li></ul>	19
Network is not available Please check the connection of the wireless router	<ul style="list-style-type: none"><li>● Your wireless router is not work properly. → Confirm your wireless router is turned on.</li></ul>	–
Connection failure	<ul style="list-style-type: none"><li>● There a problem with wireless network connection. → Move closer to the wireless router and then try connecting again.</li><li>● The setting procedure was not completed within the specified time. → Prepare all the information required for the settings, and then complete the settings within the specified time.</li></ul>	21
Cannot connect to the server Please check the settings	<ul style="list-style-type: none"><li>● The contents configured for the email server settings are not correct. → Check the configured contents and then correct them.</li><li>● The wireless router is not connected to the Internet. → Check your wireless router and connect it to the network.</li></ul>	–
Cannot connect to the server	<ul style="list-style-type: none"><li>● The wireless router is not connected to the Internet. → Check your wireless router and connect it to the network.</li></ul>	21
Cannot register Register the email server	<ul style="list-style-type: none"><li>● “Email notification address” cannot be set when the “Email server registration” is not set. → Set “Email server registration”.</li></ul>	23

Display	Cause & Solution	Page
Authentication failure Check the security type and SMTP authentication settings	<ul style="list-style-type: none"> <li>● The type of the security setting (“TLS”, “SSL”, or “None”) is not set correctly. → Set the setting correctly in “Security type”.</li> <li>● The SMTP authentication setting is not set correctly. → Set the setting correctly in “SMTP authentication”.</li> </ul>	23
Authentication failure Verify your account name or password	<ul style="list-style-type: none"> <li>● SMTP authentication setting (“Account name” or “Password”) is not set correctly. → Set the SMTP authentication setting correctly in “SMTP authentication”.</li> </ul>	20
Cannot register	<ul style="list-style-type: none"> <li>● The registering procedure was not completed within the specified time. → Confirm the following condition and try again. <ul style="list-style-type: none"> <li>– The wireless router is turned on.</li> <li>– The main monitor and your mobile device are connected to your wireless router.</li> </ul> </li> </ul>	23

### 11.1 Index

#### A

Accessories: 3

#### B

Backlight compensation: 17

Brightness

Image brightness: 14

Screen brightness: 17

#### C

Call button: 9

Camera lens: 9

Cancel

Mobile devices: 23

Changing the volume

Owner's voice volume: 17

Receiver volume: 17

Cleaning: 25

#### D

Delete all images: 20

Display: 9

Door Station: 3

Doorphone: 9

Doorphone monitoring: 12

#### E

Electric lock: 15

Email features: 23

Email settings: 20

Email notification: 20, 24

Email notification address: 20, 24

Email server deregistration: 20

Email server registration: 20, 23

Notification selection: 24

Entering text: 21

#### F

Function settings

Automatic illumination: 19

Cancel: 20

Current status: 19

Delete all images: 20

Demo mode: 20

Doorphone connection: 19

Electric lock: 15, 19

Email settings: 20

Initialization of network: 20

Initialize settings: 20

IP settings: 19

Lobby connection: 19

Notification selection: 20

Power supply frequency: 18

Register: 20

Ring volume: 18

Ringtone: 18

Select language: 11, 18

Time and date settings: 11, 18

Wide/Zoom settings: 11, 18

Wi-Fi settings: 19

Zoom position settings: 11, 18

#### G

Guide off: 17

Guide on: 17

#### I

Illumination settings

Automatic illumination: 19

Manually on/off: 17

Images (recording)

Auto image updating: 13

Delete all images: 20

Deleting: 14

Playing: 13

Initialization of network: 20

Initialize settings: 20

#### L

LED lights: 9

Lens cover: 9

Lobby connection: 19

Lobby Station: 3

#### M

Main monitor: 9

Main Monitor Station: 3

Microphone: 9

Mobile device integration: 22

Monitoring: 12

#### N

Navigator key: 9

Network connections: 21

Network settings: 19

Current status: 19

Email settings: 19, 20, 23

Initialization of network: 20

IP settings: 19

Mobile devices: 22

Notification selection: 20

Wi-Fi information: 19

Wi-Fi settings: 19, 21

Notification indicator: 9

Notification screen: 10

#### O

Owner's voice volume: 17

#### P

Pan/tilt: 17

PBX integration: 15

Playing recorded images: 13  
Press-to-talk: 12

## **R**

Recording images  
  Automatic recording: 13  
  Automatically updating recorded images: 13  
  Manually recording: 13  
Register (adding devices)  
  Mobile devices: 20, 23  
Reset: 9, 28  
Reset button: 9, 28

## **S**

Select language: 11, 18  
Soft keys: 9  
Speaker: 9  
Specifications: 25  
Supported models: 3

## **T**

Time: 11  
Time and date settings: 11  
Top menu: 10

## **V**

Voice changer: 17  
Volume: 17  
Volume heard at doorphone: 17

## **W**

Wide display: 11, 17  
Wide/zoom: 11, 17  
Wi-Fi settings: 19  
  Manual: 19  
  WPS: 19

## **Z**

Zoom display: 11, 17

**Panasonic Corporation**

1006, Oaza Kadoma, Kadoma-shi, Osaka 571-8501, Japan  
<http://www.panasonic.com>

© Panasonic Corporation 2016



\*PNQX8192XA\*

**PNQX8192XA** C0416MM2041