

Installation Guide

Model Name	Video Intercom System	Door station
Model No.	VL-SVN511 Series	VL-V555

- This guide is for use with the above 2 models.
- The VL-SVN511 models composition consists of VL-MVN511 and VL-V555.

VL-MVN511

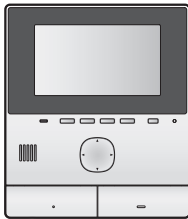

Main monitor station

VL-V555



Door station

- For VL-V555 users: Please read the areas related to the VL-V555 and also please refer to the installation guide of the main monitor that the doorphone is connected to.
- Door station is described as "doorphone" and Main monitor station is described as "main monitor" in this guide.
- In this guide, the suffix of each model number (e.g., the "BX" in "VL-SVN511BX") is omitted unless necessary.

Note to the installer

- Before attempting to connect or operate this product, please read the label on the rear of the doorphone and the main monitor.
- Please read this guide carefully, and install the product safely and correctly by following the instructions. Carefully read the information found in the section titled "For your safety" in particular.
- Only use attachments/accessories specified by the manufacturer.
- The installation shall be carried out in accordance with all applicable installation rules.
- Panasonic assumes no responsibility for injuries or property damage resulting from failures arising out of improper installation or operation inconsistent with this guide. Additionally, any resulting malfunction will not be covered under the warranty.
- After installation, make sure to leave this guide with the customer.

For your safety

To prevent severe injury and loss of life/property, read this section carefully before using the product to ensure proper and safe operation of your product.



WARNING

Preventing fire, electric shock and short circuits

- **Leave installation work to the dealer. Installation work requires technique and experiences. Failure to observe this may cause fire, electric shock, injury, or damage to the product. Consult the dealer.**
- **Electrical connection work should be performed by certified personnel only. Certification is required for performing electrical connection work. Consult your dealer.**
- Use only the specified power supply unit and AC cable.
- Do not attempt to disassemble or modify this product. Contact an authorised service centre for repairs.
- Never install wiring during a lightning storm.
- Do not connect non-specified devices.
- Do not connect a power cable to a terminal that is not specified in this guide.
- When opening holes in walls for installation or wiring, or when securing the power cable, make sure you do not damage existing wiring and ductwork.
- Do not make any wiring connections when the power supply is turned on.
- Do not use the supplied power supply unit for outdoor installations (it is for indoor use only).
- Do not install the main monitor and power supply unit in the following places:
 - Places where the main monitor and power supply unit may be splashed with water or chemicals.
 - Places where there is a high concentration of dust, or high humidity.
- Do not perform any actions (such as fabricating, twisting, stretching, bundling, forcibly bending, damaging, altering, exposing to heat sources, or placing heavy objects on the power cable) that may damage the power cable. Using the product with a damaged power cable may

cause electric shock, short circuits, or fire.

Contact an authorised service centre for repairs.

- When existing chime wires are used, it is possible that they contain AC voltage. Contact an authorised service centre.

Preventing accidents and injuries

- Do not install or use the product in health care facilities if any regulations posted in the area instruct you not to do so. Hospitals or health care facilities may be using equipment that could be sensitive to external RF (radio frequency) energy.
- Do not install or use this product near automatically controlled devices such as automatic doors and fire alarms. Radio waves emitted from this product may cause such devices to malfunction, resulting in an accident.



CAUTION





Preventing electric shock





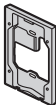

- If the wiring is underground, do not make any connections underground.
- If the wiring is underground, use a protection tube.
- If the wiring is outdoors, use a protection tube or a surge protector.







Preventing injury

- Install the product securely adhering to the instructions in this guide to prevent it from falling off the wall. Avoid installing onto low-strength walls, such as gypsum board, ALC (autoclaved lightweight concrete), concrete block, or veneer (less than 18 mm thick) walls.

Supplied accessories for installation

For the doorphone				
		 *1, *4		
Mounting base × 1	Screw × 4 (4 mm × 12 mm)	Screw × 2 (3.8 mm × 20 mm)	Name plate × 2 (incl. 1 spare)	Hex wrench × 1

For the main monitor*2		Relay box and related items*2	
			
Mounting bracket × 1	 *1	Relay box × 1 (VL-RLY1)	 *1
	Screw × 2 (4 mm × 16 mm)		Screw × 2 (4 mm × 40 mm)

Power supply unit and related items*3		Power supply unit and related items*1		
				
Power supply unit × 1 (VL-PS240)	Cable binder × 2	Power supply unit × 1 (VL-PS241)	AC cable × 1	Cable binder × 1
				 *1
				Screw × 2 (4 mm × 40 mm)

Important:

- You will need the following additional items to install and configure the doorphone and the main monitor.

[Locally procured]

- Screws (for mounting base: × 2, for mounting bracket: × 2, for relay box: × 2):*3

Prepare the screws (→the drawing on the right) according to the material, structure, strength and other factors of the mounting area and the total weight of objects to be mounted.

- Power cables (AC/DC cables), wires (for doorphone and other connections):

Prepare cables and wires of the appropriate specification. (→"Wire type and length")



Note:

- The illustrations in the supplied manual(s) may vary slightly from the actual product.

*1 VL-SVN511 AZ models only

*2 VL-V555 models not included.

*3 VL-SVN511 EX/FX models only

*4 VL-V555 BX/SX/VN models only

Precautions for installation

To avoid malfunction or communication disturbances, do not install the doorphone or the main monitor in the following locations:

- Places where vibration or any other kind of impact occurs.
- Places where echoing is frequent.
- Places near a high concentration of dust, hydrogen sulphide, ammonia, sulphur, or noxious fumes.

For the doorphone

- If a strong light is shining on the doorphone, the visitor's face may not be distinguishable. Do not place the doorphone in the following locations:
 - Where most of the background is the sky.
 - Where the background is a white wall, and direct sunlight will reflect off it.
 - Where direct sunlight will shine on the doorphone.
- Do not place the doorphone in locations where echoing occurs, as this will cause the doorphone to beep frequently.
- Dust protection/water protection is IP54.
Only when installation work specified in this guide is properly performed and appropriate water protection treatment is performed.
- Make sure the rear of the doorphone is not subject to water.
- Depending on the installation location, condensation may form on the doorphone's lens cover. This may cause images to become obscured. Condensation will dissipate as the temperature rises.

For the main monitor

- Install the main monitor away from electronic appliances such as TVs, radios, personal computers, air conditioners, boiler control panels with intercom, home security equipment, wireless devices, or digital cordless phones.
- Do not install the main monitor in places where it will be affected by extremely high-frequency radio waves (near broadcasting antennas etc.). This may cause the display to flicker or an interrupting noise to occur.
- Leave at least 20 cm of space above, below, and to the left and right sides of the main monitor. Do not install on a wall that is deeply recessed.
- Do not install the main monitor inside a wall.
- Be sure to install the main monitor more than 5 m away from the doorphone.
- The product operates in the frequency range of 2.412 GHz and 2.472 GHz with a peak transmission power of 100 mW (max.). Refer to the "For best performance" section in the Operating Instructions.
- In areas surrounded by a high electrical field, disturbances may occur in the main monitor's image or sound.

Wiring schematic diagram

Set up correctly according to the following wiring schematic diagram and "Wire type and length".

- For information, such as order numbers, about optional devices that can be connected to, refer to the "Additional/replacement accessories" section in the Operating Instructions.
- For VL-V555 users: Refer to the wiring diagram of the Video Intercom device that VL-V555 is connected to.

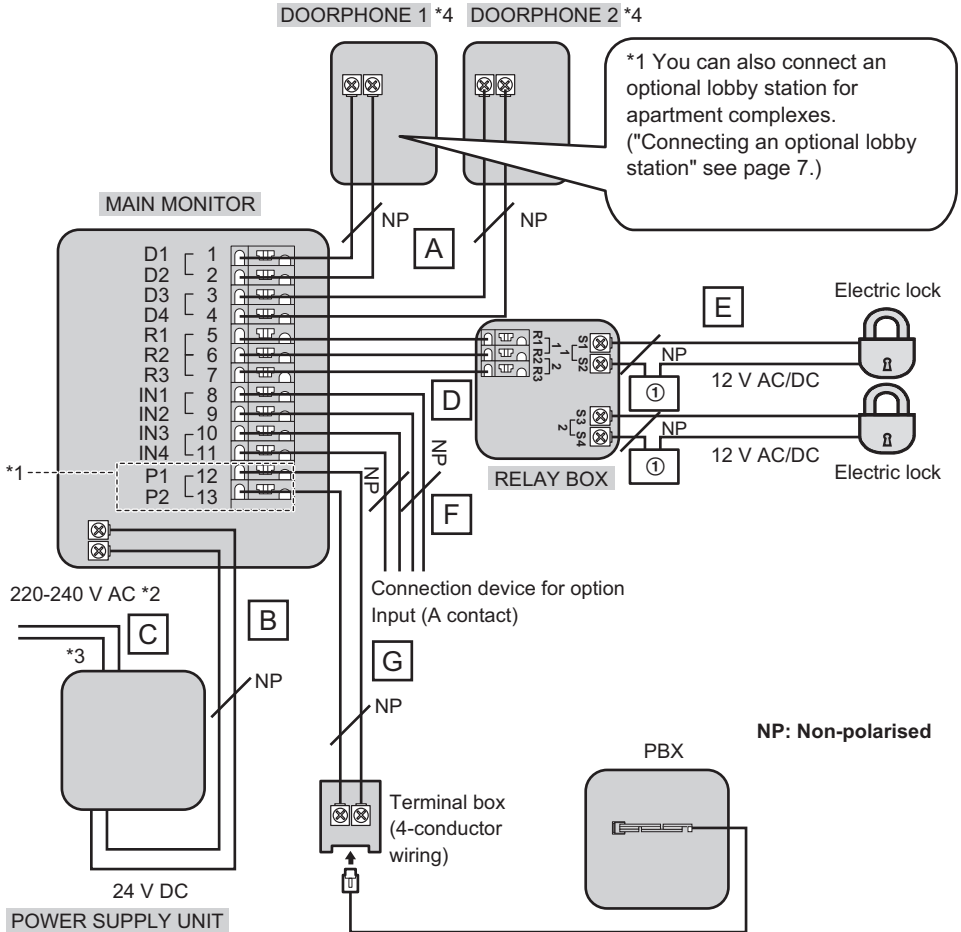

① Power supply

*1 VL-SVN511AZ models only

*2 VL-SVN511EX/FX models only

*3 VL-SVN511 AZ models: Use only the supplied AC cable.

*4 When you use an additional doorphone, the maximum number of the electric locks that can be connected to the doorphone depends on the type of doorphone. Consult your dealer for further information.

For VL-V554 users:

- Make sure to only connect electric vehicle gate locks to the S3/S4 terminals of the doorphones.
- Make sure to only connect electric door locks to the S1/S2 terminals of the doorphones.

Wire type and length

Wiring run		Wire type *1		
		Diameter		Length (Max.)
Main monitor – Doorphone (including lobby station)	A	ø 0.65 mm	22 AWG	100 m
		ø 1.0 mm	18 AWG	130 m
		ø 0.5 mm	CAT 5	50 m
Main monitor – Power supply unit	B	ø 0.65 mm	22 AWG	10 m
		ø 1.0 mm	18 AWG	20 m
Power supply unit – AC power source	C	ø 1.2 mm – ø 2.0 mm (17 AWG – 12 AWG)		No requirement
Main monitor – Relay box	D	ø 0.65 mm	22 AWG	100 m
		ø 1.0 mm	18 AWG	130 m
Relay box – Electric lock *2	E	ø 0.5 mm – ø 1.2 mm (24 AWG – 17 AWG)		According to specification of connected device.
Main monitor – Connection device for option input (A contact) *2	F	ø 0.5 mm – ø 1.2 mm (24 AWG – 17 AWG)		According to specification of connected device.
Main monitor – PBX	G	ø 0.65 mm	CAT 3 or 22 AWG	100 m

*1 Type: Single-pair cable with outer sheath (jacket)

Conductor: Copper solid

- A certified power supply wiring has to be used with this equipment. The relevant national installation and/or equipment regulations shall be considered. A certified power supply wiring not lighter than ordinary polyvinyl chloride flexible wiring according to IEC 60227 shall be used.

*2 When using an electric lock or a connection device for option input (A contact), select a device that meets the following guidelines:

- Electric lock connection terminal (S1/S2, S3/S4):
 - N/O dry closure contact
 - 12 V AC/DC, less than 1 A
- Connection device for option input (A contact) terminal (IN1/IN2/IN3/IN4):
 - Input method: No-voltage contact
 - Open-circuit voltage between terminals: DC 7 V or less
 - Detection definite time: 0.1 second or more
 - Short-circuit between terminals: 5 mA or less
 - Resistance value: make: 500 Ω or less make, break: 15 KΩ or more

■ Connecting an optional lobby station (VL-SVN511AZ models only)

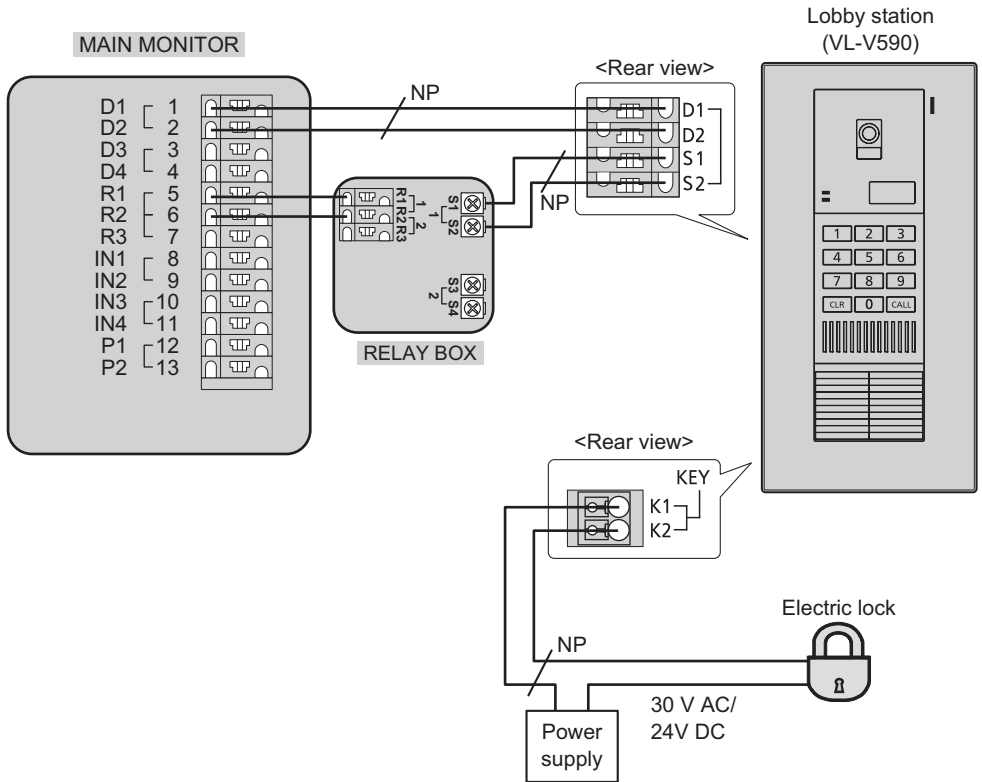

NP: Non-polarised

<Connecting an optional lobby station for apartment complexes>

- Be sure to perform the following to ensure proper operation
 - Connect terminal D1/D2 on the main monitor with terminal D1/D2 on the lobby station.
 - Connect terminal R1/R2 on the main monitor with terminal R1/R2 on the Relay box.
 - Connect terminal S1/S2 on the Relay box with terminal S1/S2 on the lobby station.
 - After connecting to the main monitor, change the [Lobby connection] setting to [Connected devices] using the main monitor. (→Operating Instructions of the Video Intercom System.)
- For information about lobby station connections, refer to the manuals of the lobby station.

Doorphone installation position

Installation height and area visible by the camera lens (when connected to VL-SVN511 series)

You can use the [Wide/Zoom settings] setting on the main monitor to select the area that is visible when a visitor calls; available settings are [Wide] and [Zoom]. (Default setting: [Wide])

- The following values are for when the doorphone is installed in the standard position (the centre of the doorphone's height is approximately 1450 mm) and the visitor is approximately 500 mm away from the camera lens.

When set to wide (default)

(Units: mm)

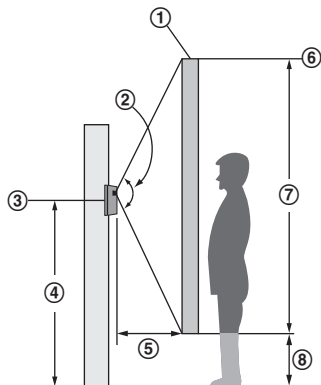

A view when looking from above

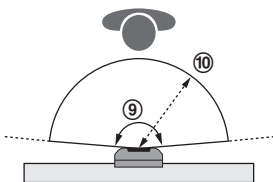
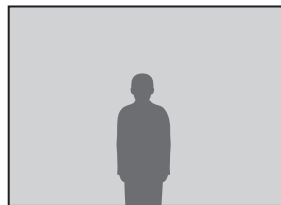

Image displayed on main monitor



- ① Image range ② Approx. 130° ③ Centre of doorphone ④ Approx. 1450 ⑤ Approx. 500
⑥ Approx. 2500 ⑦ Approx. 2100 ⑧ Approx. 400 ⑨ Approx. 170° ⑩ Approx. 500

When set to zoom

Displays a portion of the wide image at 2 times the size.

- The zoom feature uses a digital zoom. As a result, the image quality of zoomed images is lower than wide display images.

Image displayed on main monitor

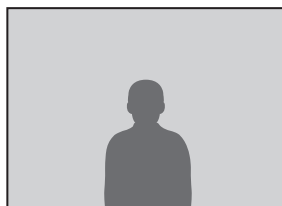

- You can use the main monitor's [Zoom position settings] setting to select the desired area visible when zooming.

Refer to the following and configure the main monitor.

Up and down

(Units: mm)

Up

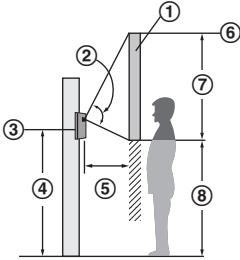

- ① Image range ② Approx. 80° ③ Center of doorphone ④ Approx. 1450 ⑤ Approx. 500
⑥ Approx. 2500 ⑦ Approx. 1200
⑧ Approx. 1300

Centre (default)

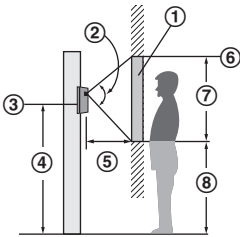

- ① Image range ② Approx. 80° ③ Center of doorphone ④ Approx. 1450 ⑤ Approx. 500
⑥ Approx. 1900 ⑦ Approx. 900 ⑧ Approx. 1000

Down

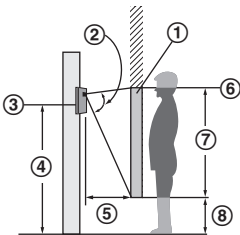

- ① Image range ② Approx. 80° ③ Center of doorphone ④ Approx. 1450 ⑤ Approx. 500
⑥ Approx. 1600 ⑦ Approx. 1200 ⑧ Approx. 400

Left and right (when looking from above)

(Units: mm)

Left

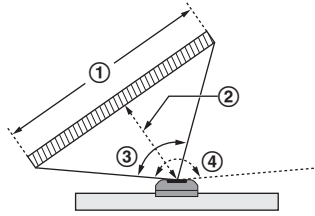

- ① Image range: Approx. 1200 ② Approx. 500
③ Approx. 100° ④ Approx. 170°

Centre (default)

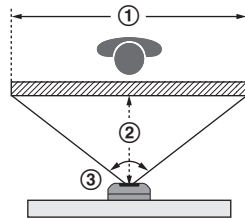

- ① Image range: Approx. 1300 ② Approx. 500
③ Approx. 105°

Right

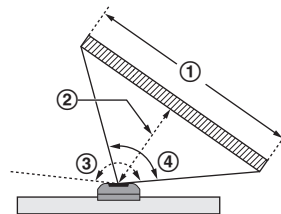

- ① Image range: Approx. 1200 ② Approx. 500
③ Approx. 170° ④ Approx. 100°

Installing the doorphone

Important:

- On the bottom surface of the doorphone and the mounting base, there are holes to allow water to drain. Do not cover them up when installing.
- When existing wiring (such as chime wires) is used:
 - It may contain AC voltage that may cause electric shock and/or damage the product.
 - Never use the following types of wiring. Consult a qualified technician/dealer.

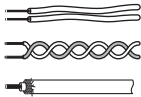

- See "Wire type and length" for information about wiring materials.

1 Attach the mounting base (2) (accessory) to the wall securely.

- Install the mounting base on a vertical flat wall.

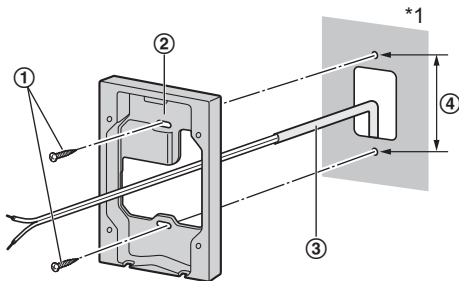

- ① Screws (locally procured) × 2
(VL-SVN511AZ, VL-V555BX/SX/VN models: included)

- ③ Wire (locally procured)

- ④ 83.5 mm

*1 To prevent dew condensation, fill a hole for wiring as much as possible.

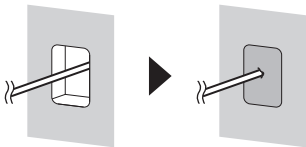

When using mounting box (option): Model No. VL-MB554

Install the flush mounting box (1) in the wall.

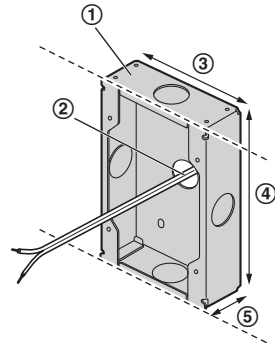

- ② Knockout hole*1

- ③ 100 mm ④ 151 mm ⑤ 37 mm

*1 Only open the knockout holes as required for the wiring.

2 Use a hex wrench (1) (accessory) to loosen screw A (2) and remove the front panel (3) of the doorphone.

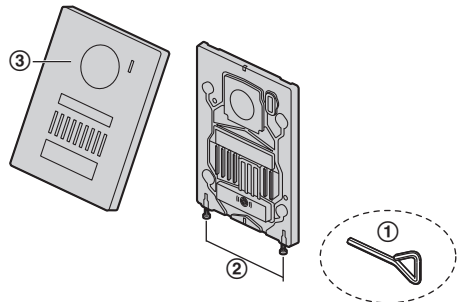

- ① 2 mm hex wrench

- 3** Connect the wires.
Loosen the screws. Push in the wires to the terminal connectors (non-polar), then tighten the screws (①).

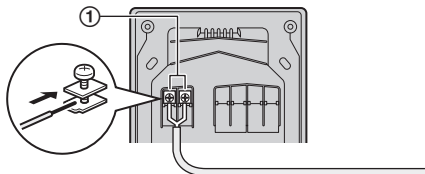

- ① – Recommended torque: 0.5 N·m
{5.1 kgf·cm}
– Maximum torque: 0.7 N·m {7.1 kgf·cm}

- 4** Attach the doorphone to the mounting base.

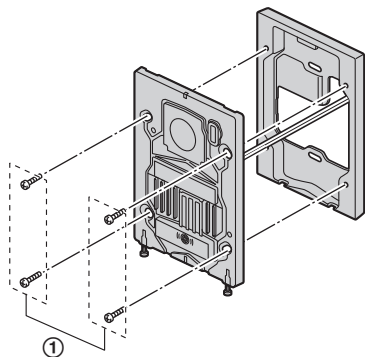

- ① Screws (accessory) × 4

When using mounting box (option):

Model No. VL-MB554

Attach the doorphone to the flush mounting box.

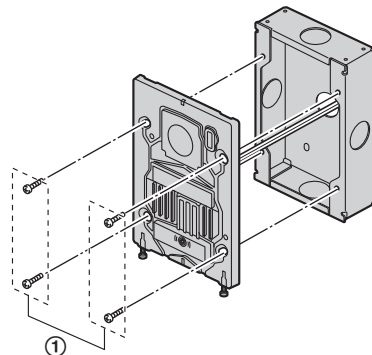

- ① Screws (accessory) × 4

- 5** Attach the name plate (①) (accessory) to the doorphone and use screw A (②) to secure the front panel.

- Write the name on the name plate as needed.

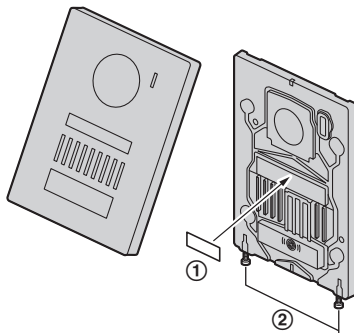

- ② Recommended torque: 0.35 N·m
{3.6 kgf·cm}

Installing the power supply unit (VL-SVN511EX/FX models only)

About the installation location

- The device must be installed inside an electrical panel or cabinet.
- A readily accessible disconnect device shall be incorporated external to the equipment.
 - External disconnect device must be certified and have a creepage and clearance distance of 3 mm or more.

Precautions for wiring

- Make sure you turn off the power at the breaker before performing any wiring work.
- Always connect AC or DC cables to the appropriate connection terminals. Incorrectly connecting the AC or DC cables may damage the power supply unit.
- To prevent the power cables from disconnecting and to prevent electric shock, secure the power cables using the cable binders (accessory) and attach the cable covers.

How to connect the power cable (AC/DC):

Connect the power supply unit (accessory) and AC/DC cables (locally procured).

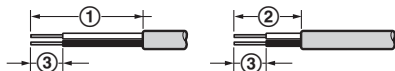

- ① 45 mm ② 25 mm ③ 7 mm

Front view

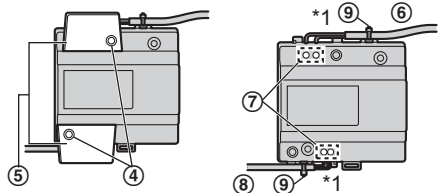

- ⑥ AC cable ⑧ DC cable

*1 Do not connect the AC cable and DC cable inversely. That would be a cause of malfunctions.

Make sure that there are no bare wires exposed outside the product.

Power supply unit (with cable covers removed)

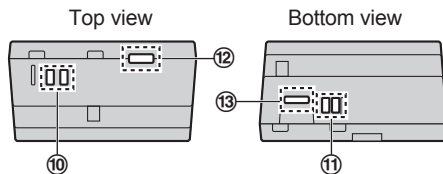

⑫ AC cable binder hole

⑬ DC cable binder hole

1 Strip the AC/DC cables as follows:

AC cable (①, ③), DC cable (②, ③)

2 Remove the screws (④) and then remove the cable covers (⑤).

3 Connect the AC cable (⑥) to the AC IN terminal (⑩)/DC cable (⑧) to the DC OUT terminal (⑪) on the top and bottom of the power supply unit, and then secure the wires by tightening the screws (⑦).

• Recommended torque:

- AC terminal: 0.5 N·m {5.1 kgf·cm}
- DC terminal: 0.45 N·m {4.6 kgf·cm}

⚠ CAUTION

Insert the cables firmly all the way into the terminals. If the cables are not inserted all the way, heat may be generated.

4 Use the cable binders (⑨) (accessory) to secure the AC/DC cables (⑥) (⑧) (double-coated area) to the power supply unit.

5 Make sure to replace the cable covers (⑤).

Attach to the DIN rail

Attach in the order described below so that hook (①) is positioned at the bottom.

1 Hang hook (②) on the DIN rail (③).

2 Pull and hold the lever down (④).

3 Secure hook (①) to the DIN rail (⑤).

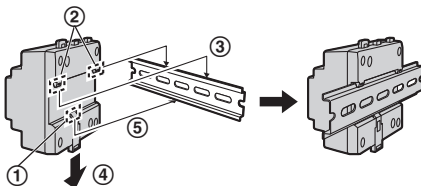

Installing the power supply unit (VL-SVN511AZ models only)

About the installation location

- The AC cable plug is used as the main disconnect device. Ensure that the power outlet is installed near the product and is easily accessible.
- A readily accessible disconnect device shall be incorporated external to the equipment.
 - External disconnect device must be certified and have a creepage and clearance distance of 3 mm or more.

Precautions for wiring

- Make sure that the power supply unit is unplugged before performing any wiring work.
- Always connect AC or DC cables to the appropriate connector or connection terminal.
- To prevent the DC cable from disconnecting and to prevent electric shock, secure the DC cable using the cable binder (accessory) and attach the cable cover.

How to connect the AC cable and DC cable:

Connect the power supply unit (accessory), the AC cable (accessory), and a DC cable (locally procured).

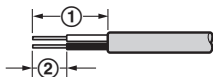

① 25 mm ② 7 mm

Front view

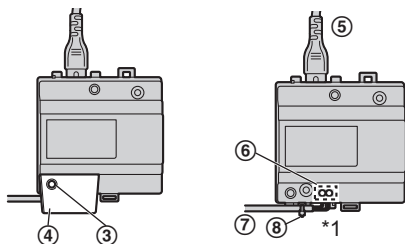

*1 Make sure that there are no bare wires exposed outside the product.

Power supply unit (with cable cover removed)

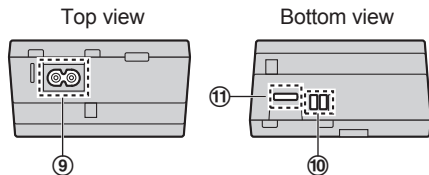

⑪ DC cable binder hole

- 1 Strip the DC cables as follows:
DC cable (①, ②)
- 2 Remove the screws (③) and then remove the cable cover (④).
- 3 Connect the AC cable (⑤) (accessory) to the AC IN connector (⑨) on the top of the power supply unit. Next, connect the DC cable (⑦) (locally procured) to the DC OUT terminal (⑩) on the bottom of the power supply unit, and then secure the wires by tightening the screws (⑥).
 - Recommended torque: 0.45 N·m {4.6 kgf·cm}

⚠ CAUTION

Insert the cables firmly all the way into the connector and terminals. If the cables are not inserted all the way, heat may be generated.

- 4 Use the cable binder (⑧) (accessory) to secure the DC cable (⑦) (double-coated area) to the power supply unit.
- 5 Make sure to replace the cable cover (④).

Wall mounting

Attach the power supply unit to the wall securely.

- ① Screws (locally procured) × 2
(VL-SVN511AZ models: included)

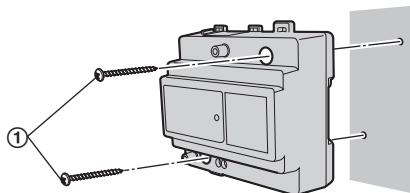

Main monitor installation position

About the installation position of the main monitor and mounting bracket

- Place the main monitor in a location that your eyes are the same height as the centre of the display.
- For the following reasons, leave at least 20 cm (①) of space above, below, and to the left and right sides of the main monitor:
 - To prevent malfunction and sound cutting out
 - To ensure to make sure the reset button (②) can be used (the reset button is on the bottom of the main monitor)

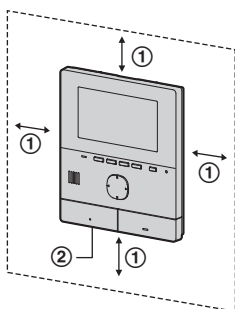

- After deciding where to install the main monitor, attach the mounting bracket in the location shown below.

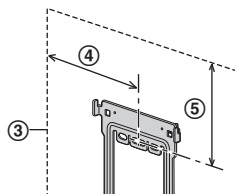

- ③ Main monitor installation position
- ④ 80.5 mm
- ⑤ 86.8 mm

Installing the main monitor

- Attach the mounting bracket (①) to the wall securely.
 - Install the mounting bracket on a vertical flat wall (②).

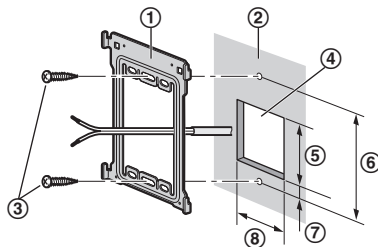

- ③ Screws (locally procured)
(VL-SVN511AZ models: included)
- ④ Hole in wall ⑤ 60 mm ⑥ 83.5 mm
- ⑦ 7 mm ⑧ 50 mm

- Connect the DC cable and wires.
 - Connect the wires correctly according to "Wiring schematic diagram".

2-1 How to connect the DC cable

- Remove screw A (①) and then remove the terminal cover.
- Loosen screw B (②) and push in the wires of the DC cable to the terminal connectors (non-polar), then tighten the screws.
 - Recommended torque: 0.8 N·m {8.2 kgf·cm}
- Use the cable binder (⑤) (accessory) to secure the DC cable (double-coated area) to the main monitor.
- Make sure to replace the terminal cover.

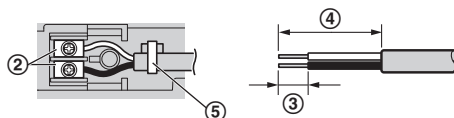
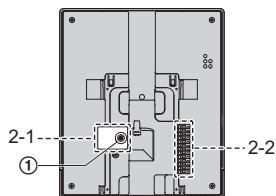

- Bare wire at tip
- ③ 7 mm ④ 30 mm

2-2 How to make wiring connections

While pressing on the button (6) with a pointed object such as a screwdriver, insert the wire into the terminal connector (7). (To disconnect a wire, while pressing on the button (6), pull out the wire.)

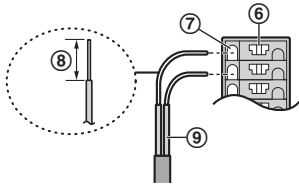

- ⑧ Bare wire at tip 9mm
- ⑨ Wiring from doorphone

Important:

Do not connect the power cable.
(Damage may occur.)

- 3 Mount the main monitor to the mounting bracket.

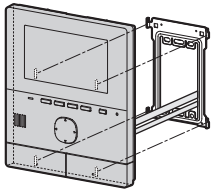

3-1 Line up the tab on the bottom of the bracket with the groove on the main monitor.

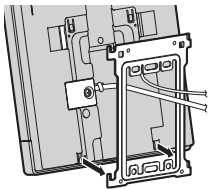

3-2 Line up the tab on the top of the bracket with the groove on the main monitor, and push the main monitor down until it is secure.

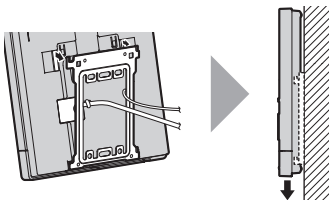

Installing the relay box

Wiring when you connect the main monitor cable and electric lock using relay box

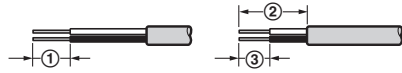

- ① 9 mm ② 25 mm ③ 7 mm

Front view

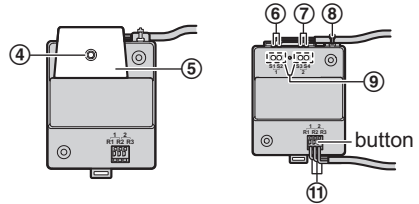

Relay box (with cable cover removed)

Top view

Bottom view

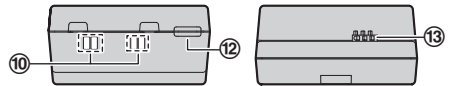

- ⑫ Cable binder hole

- 1 Strip the cables from main monitor (1) and cable from electric lock (2, 3)
- 2 Remove the screw (4) and then remove the cable cover (5).
- 3 Connect the cables from the electric lock (6, 7): if 2 electric locks are connected to the electric lock terminal (10) on the top of the relay box and then secure the wires by tightening the screws (9).
 - Recommended torque: 0.45 N·m {4.6 kgf·cm}
- 4 Use the cable binder (8) (accessory) to secure the cables from electric lock (6, 7) (double-coated area) to the relay box.
- 5 Make sure to replace the cable cover (5).
- 6 While pressing on the button with a pointed object such as a screwdriver, insert the cable from main monitor (11) into the main monitor terminal connector (13). (To disconnect a cable while pressing on the button, pull out the cable.)

When installing on a wall

For more information, refer to "Attach to the DIN rail" (page 12) and "Wall mounting" (page 13).

Panasonic System Networks Co., Ltd.
1-62, 4-chome, Minoshima, Hakata-ku, Fukuoka 812-8531, Japan
<http://www.panasonic.com/>

© Panasonic System Networks Co., Ltd. 2015

PNQP1255ZA C1015MM0